

Wireless Charging Tray

VW Arteon 2017>

VW Passat (B8) 2014>

241320-52-1

INBAY

WIRELESS CHARGING

D

EINBAUANLEITUNG

Schwierigkeitsgrad

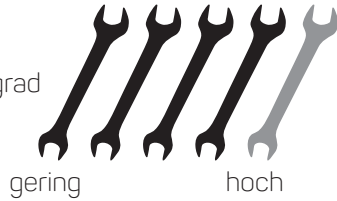

gering

hoch

GB

INSTALLATION GUIDE

level of difficulty



low

high

Nur für Modelle ohne Raucherpaket*

*Fahrzeuge mit "Raucherpaket" benötigen zum

Einbau folgendes Original VW Zubehörteil :

"Ablage Koppelantenne" (VW Teile-Nr.: 3G1 863 071A 82V)

Hinweis: Entfall der USB-Buchse in der Mittelkonsole

Only for models without „smoker's package“*

* Vehicles with „smoker's package“ require

the following original VW accessory part :

„Pocket GSM Antenna (VW part no.: 3G1 863 071A 82V)

Info: The USB socket in the center console is not retained

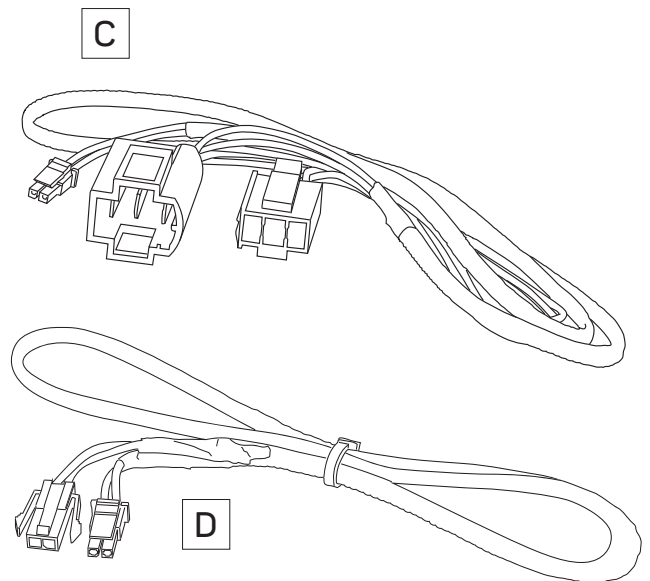
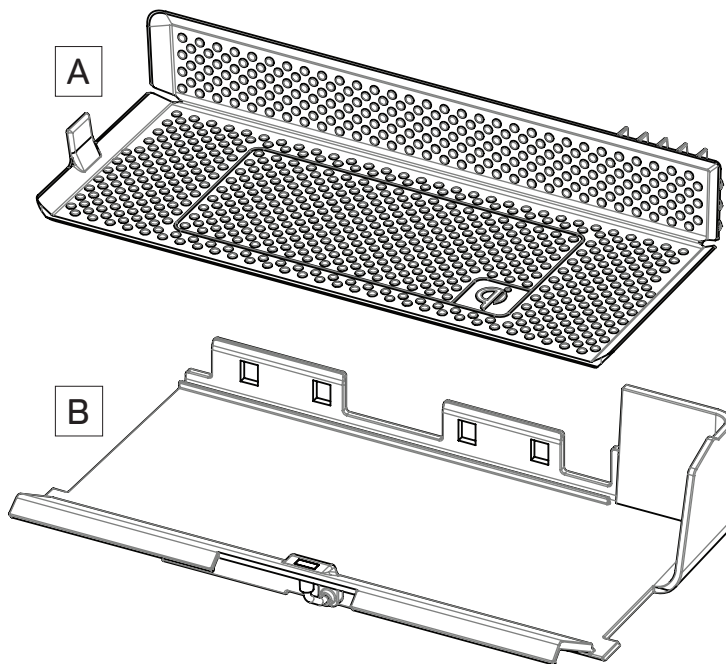

Sachgemäße Installation unter Beachtung dieser Einbauanleitung erforderlich. Achten Sie auf korrekte Anschlüsse. Verlegen Sie die Kabel so, dass Sie weder geknickt, gequetscht oder beschädigt werden können. Sorgen Sie dafür, dass sich die Kabel nicht in Gegenständen verfangen können.

Wir können keine Haftung für Schäden übernehmen, welche durch unsachgemäße Installation oder Nutzung verursacht wurden. Verwenden Sie darum ausschließlich das mitgelieferte Montagematerial.

Technische Änderungen vorbehalten, alle Angaben ohne Gewähr.

Das „Qi“ Logo ist Warenzeichen des „Wireless Power Consortium“

An appropriate installation in observance of these operating instructions is necessary. Please make sure the wiring is arranged so it is not bended or crimped due to the risk of cable break. Make sure that all connections are correct. Route the cable away from moving parts, do not allow the cable to be entangled, pinched or damaged in any way.

We will not be liable for damage due to improper installation or utilization. Use the specified accessory parts to prevent product failure.

Subject to technical modifications; no responsibility is accepted for the accuracy of this information.

The “Qi” symbol is a trademark of the “Wireless Power Consortium”

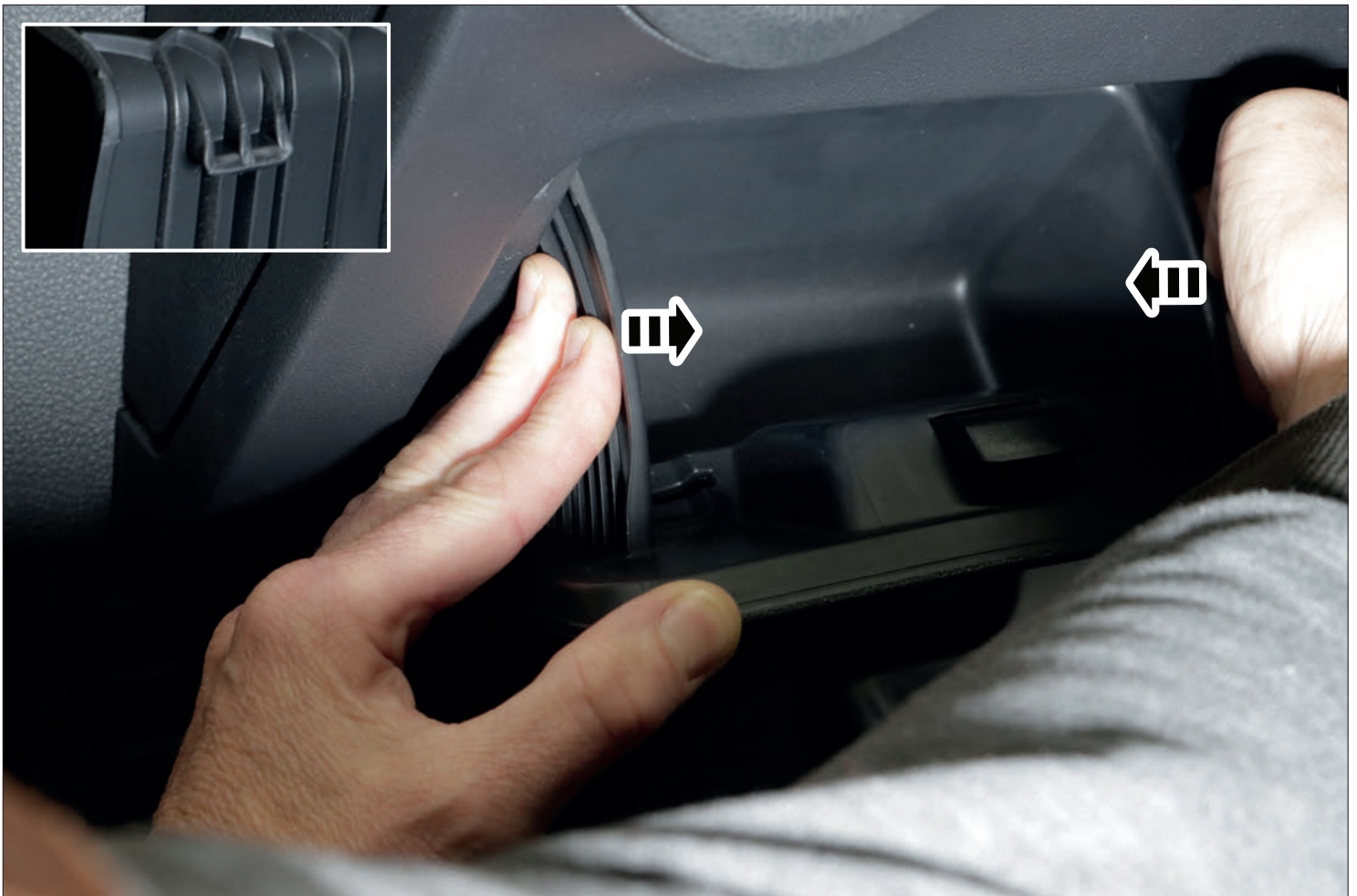

ACHTUNG!
Die 20A Sicherung muss sich genau an dieser Position befinden !

IMPORTANT!
The 20A fuse has to be exactly in this position !

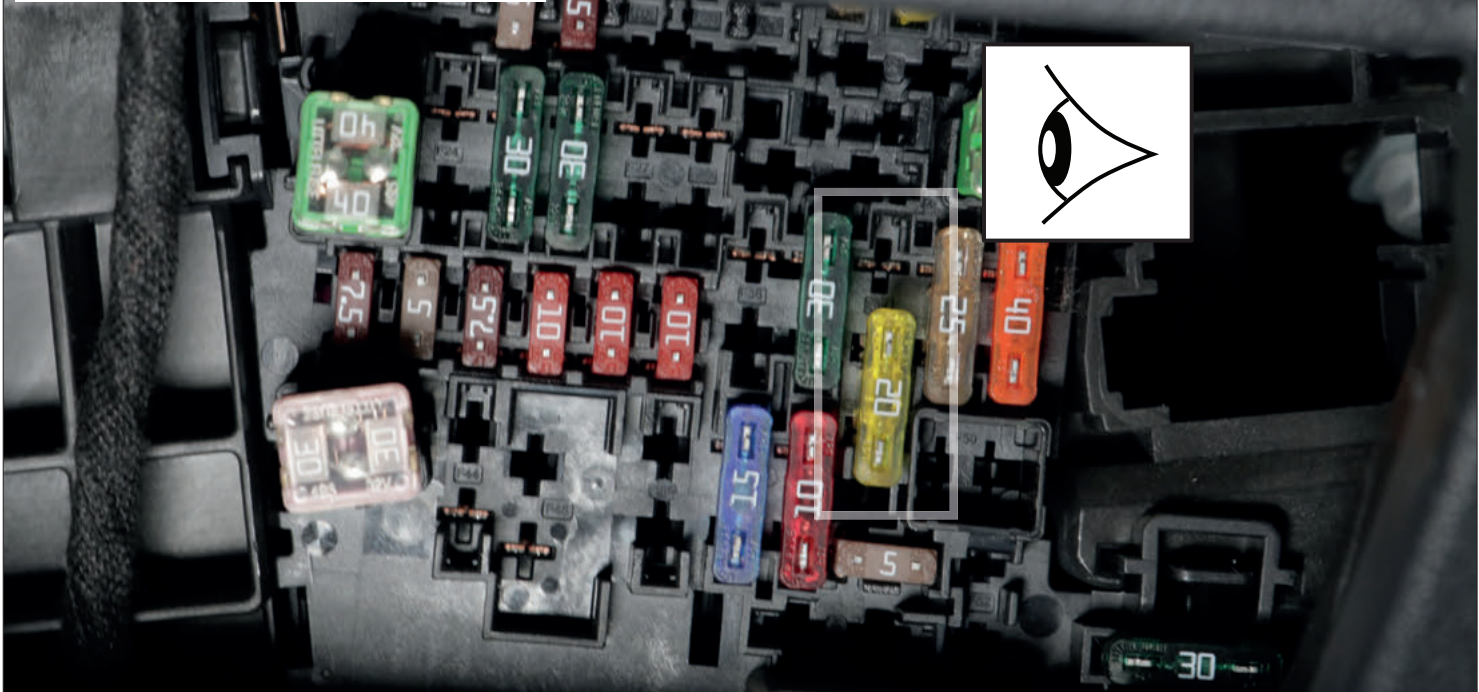

Falls sich die 20A Sicherung an einer anderen Position befinden sollte, stecken Sie diese um !

Switch the place of the 20A fuse if it is at this position !

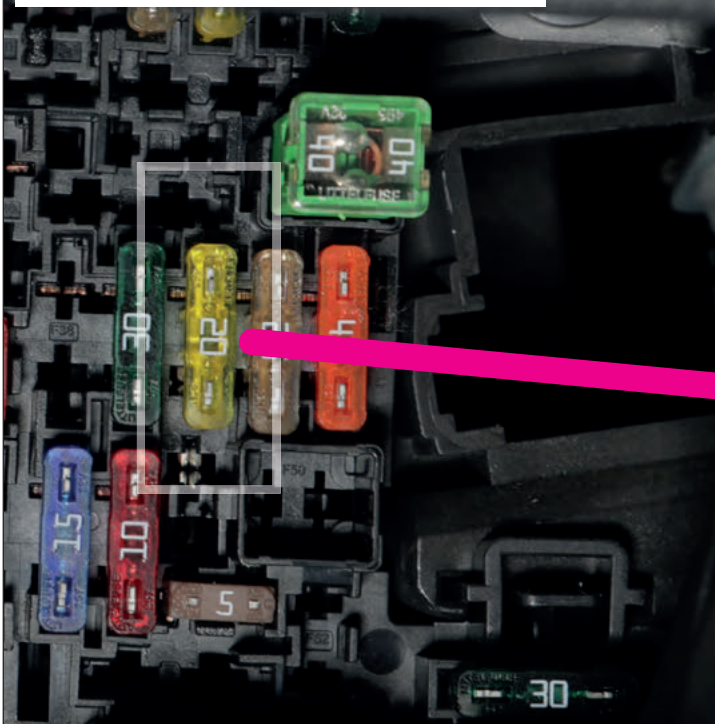

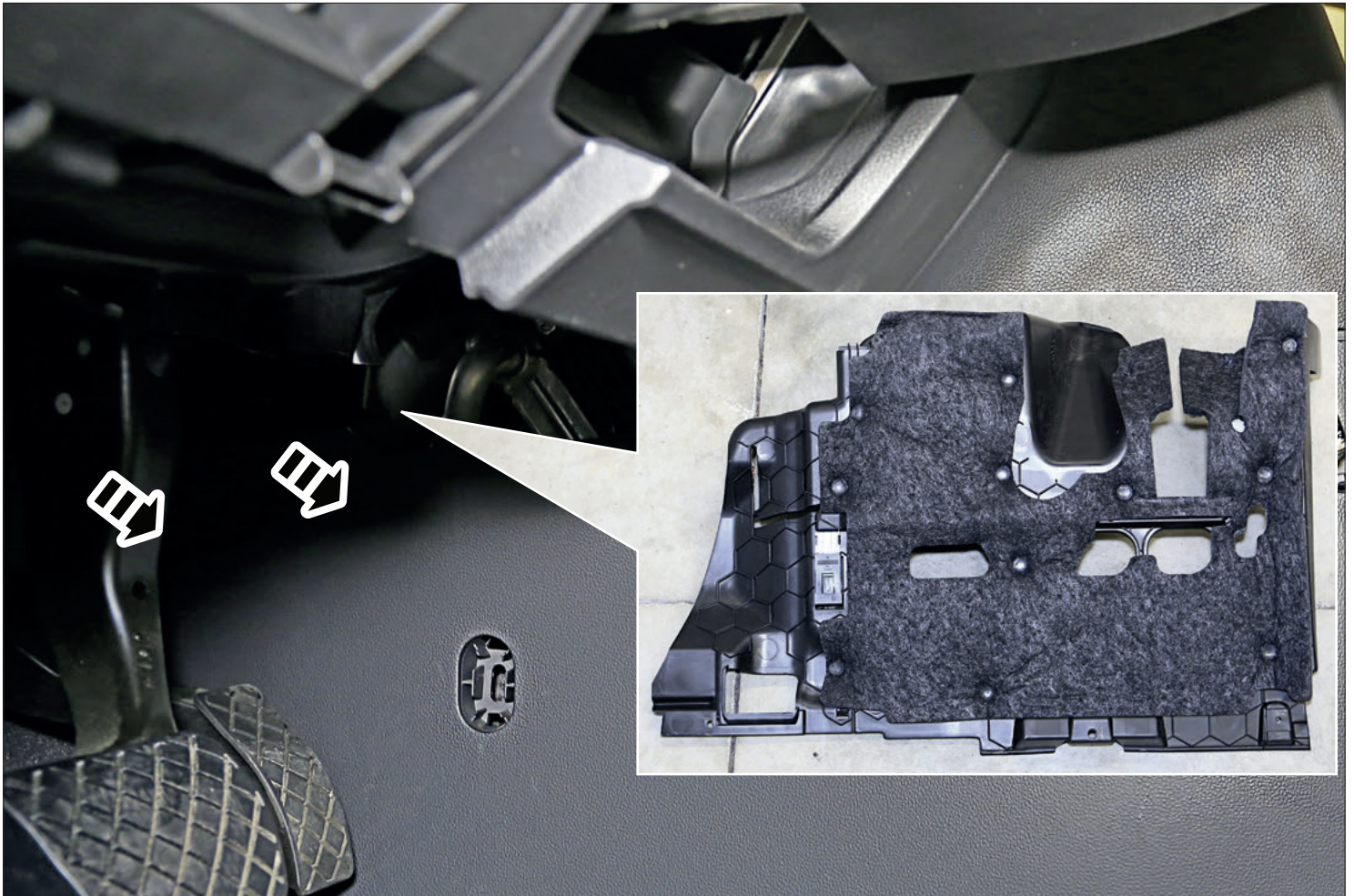

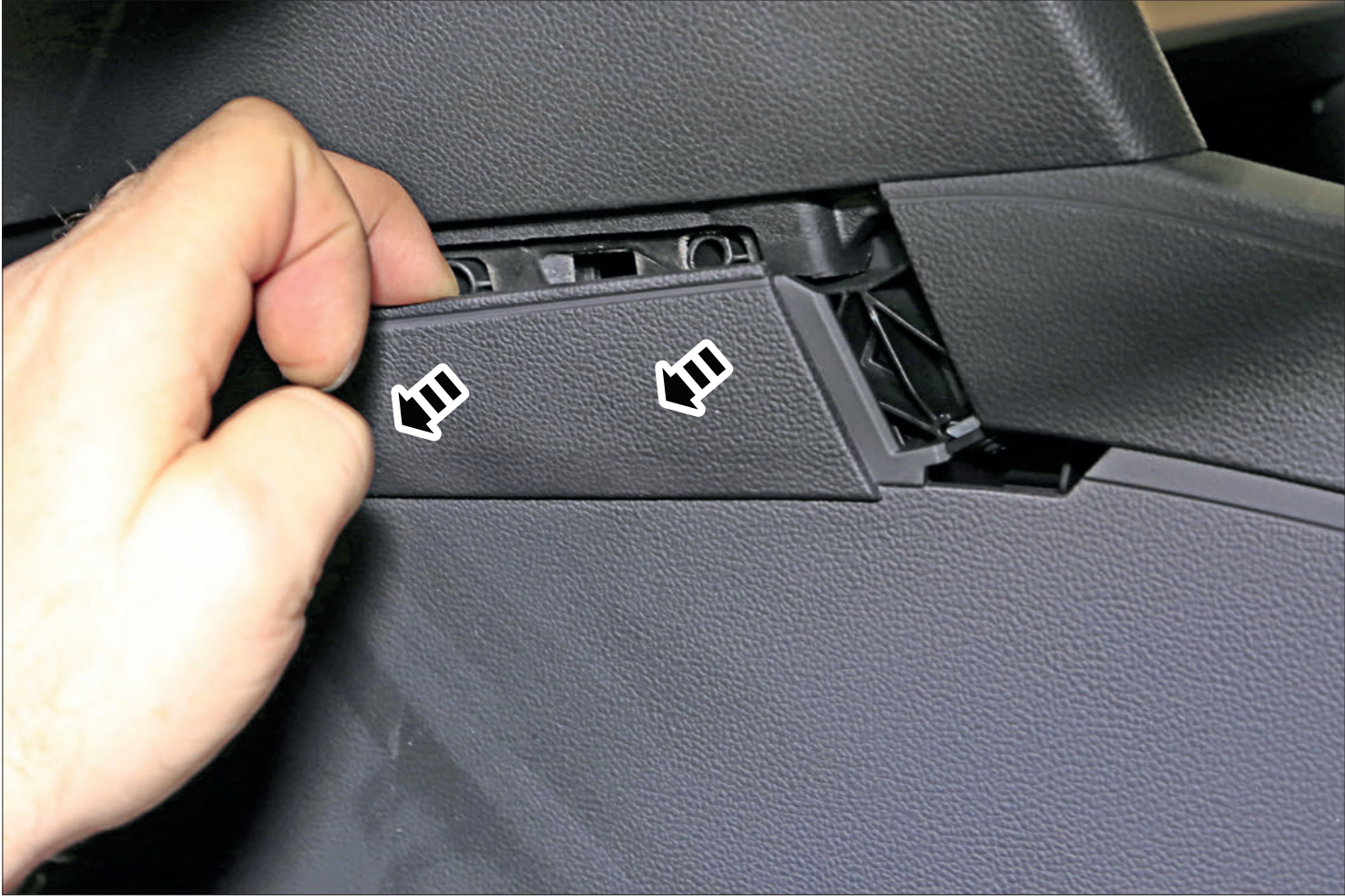

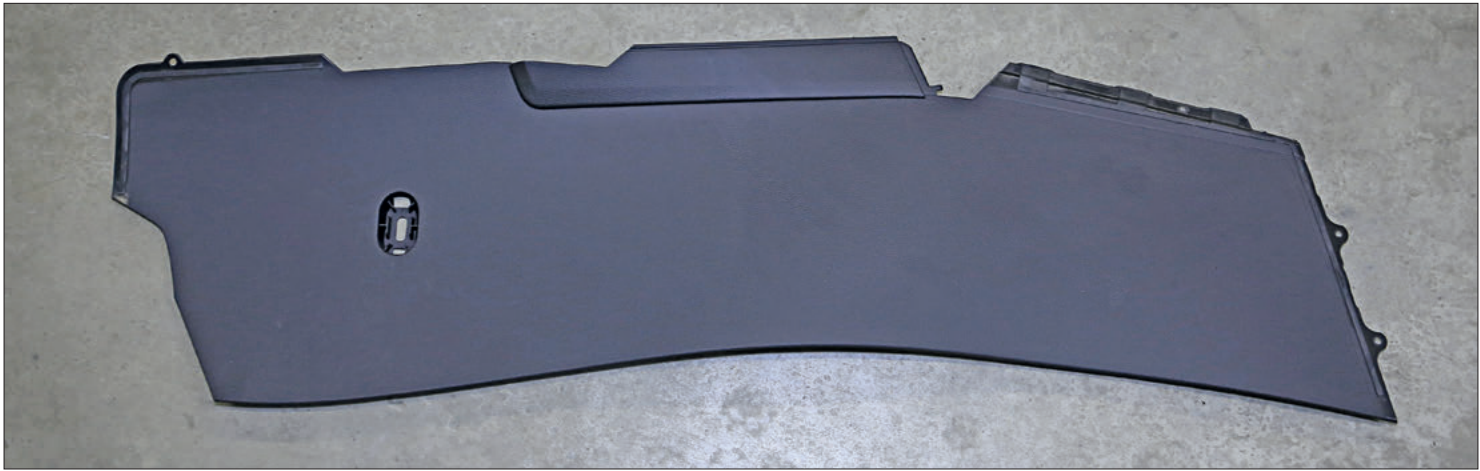



Sollte Ihr Fahrzeug keine +12V Buchse unterhalb der Lüftungskonsole für die Fondpassagiere besitzen, muss die +12V Buchse der Mittelkonsole zur Stromversorgung genutzt werden (Siehe Seite 24 - 25).

In case your vehicle is not equipped with a +12 V socket underneath the air vent console for rear seat passengers you have to use the +12 V on the center console for power supply* (see pages 24 -25).

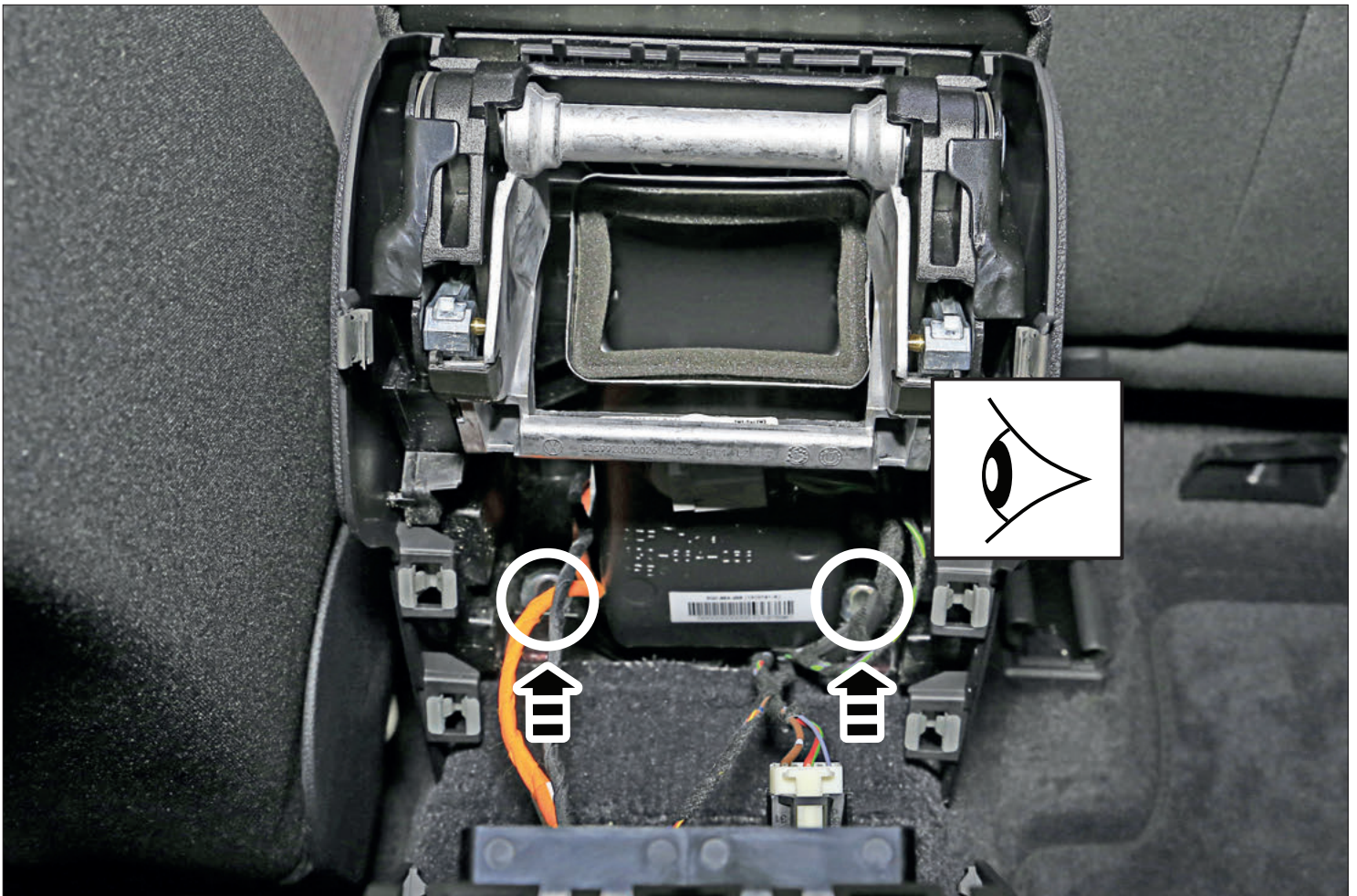

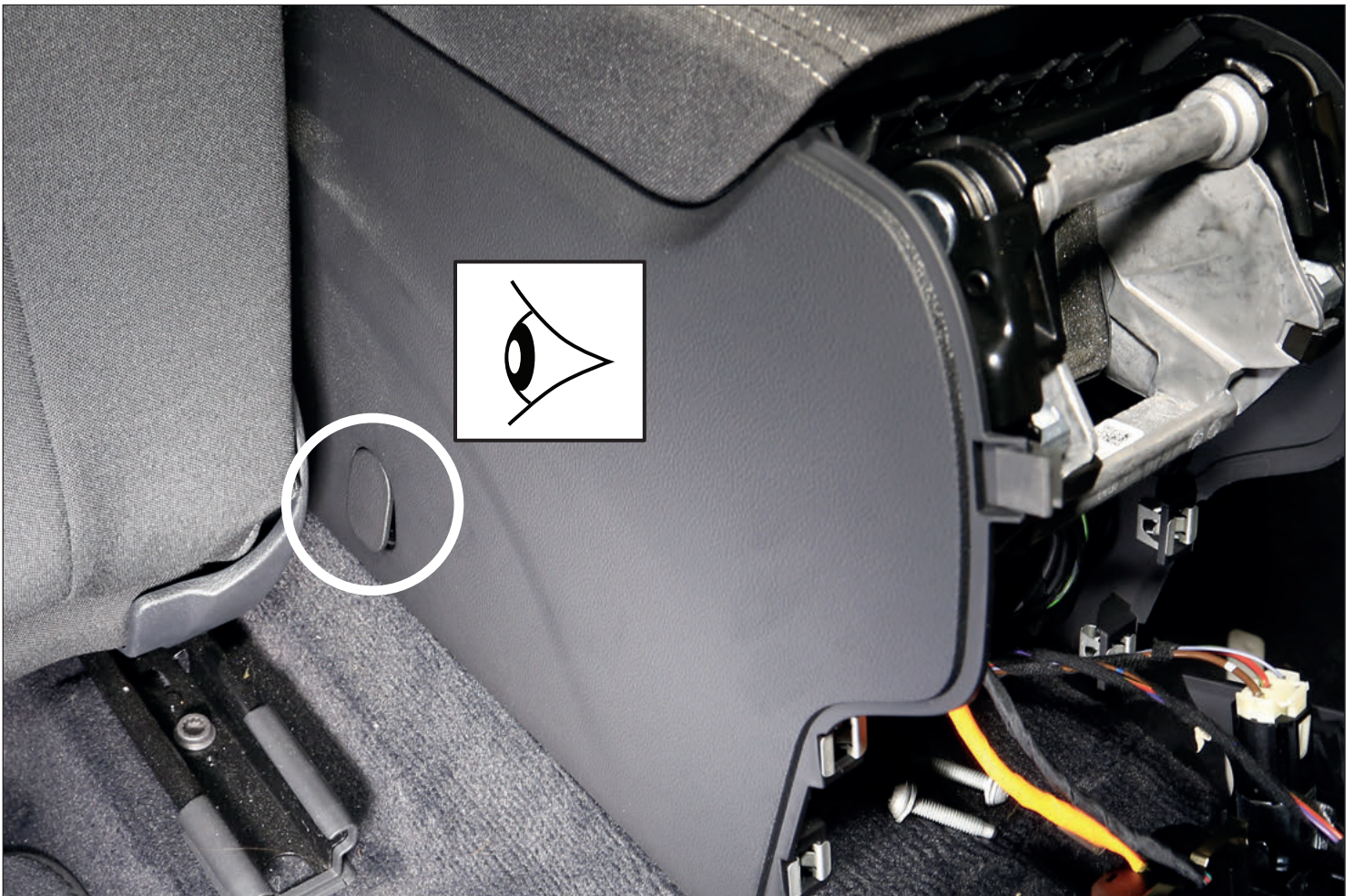
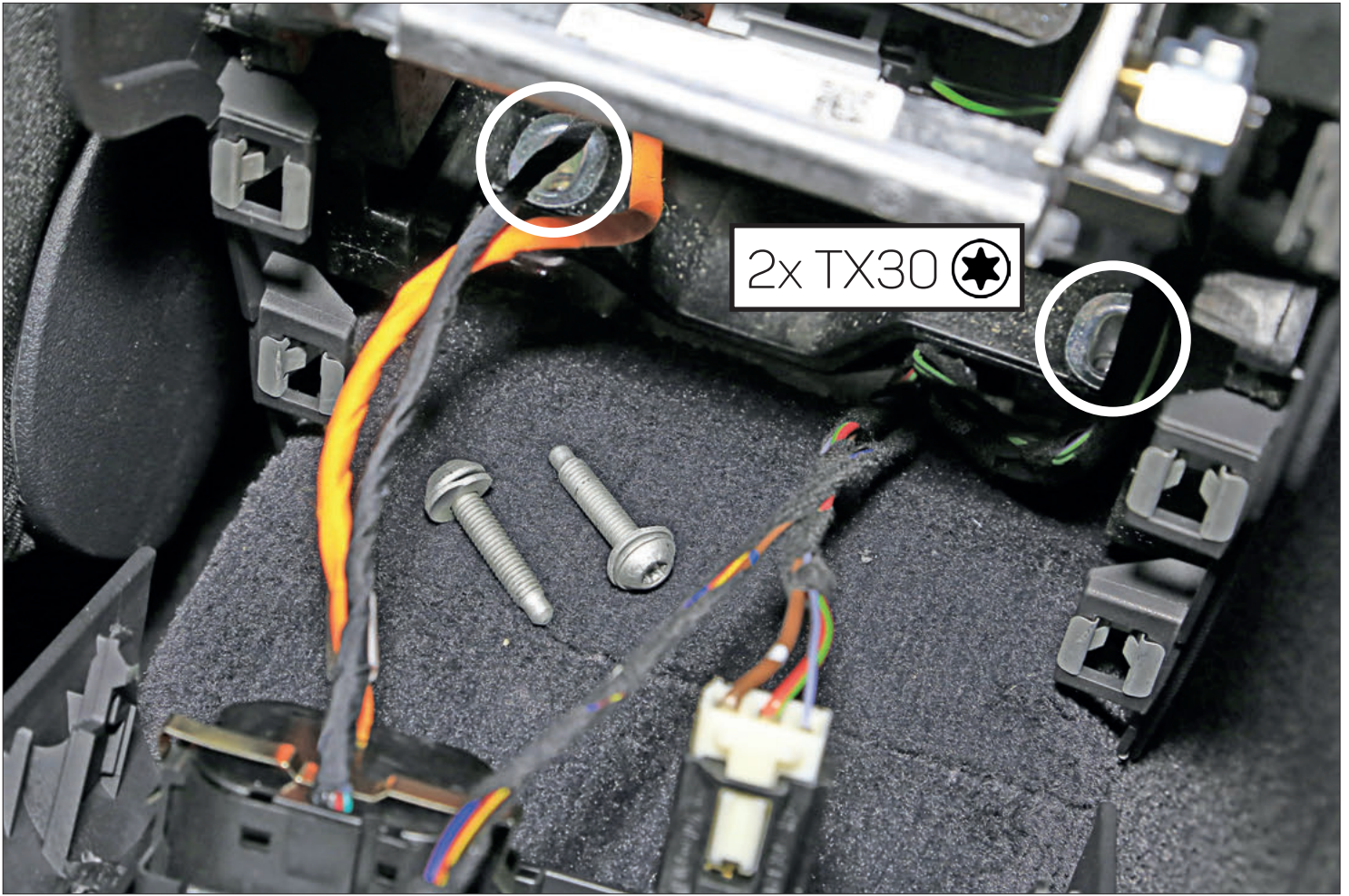

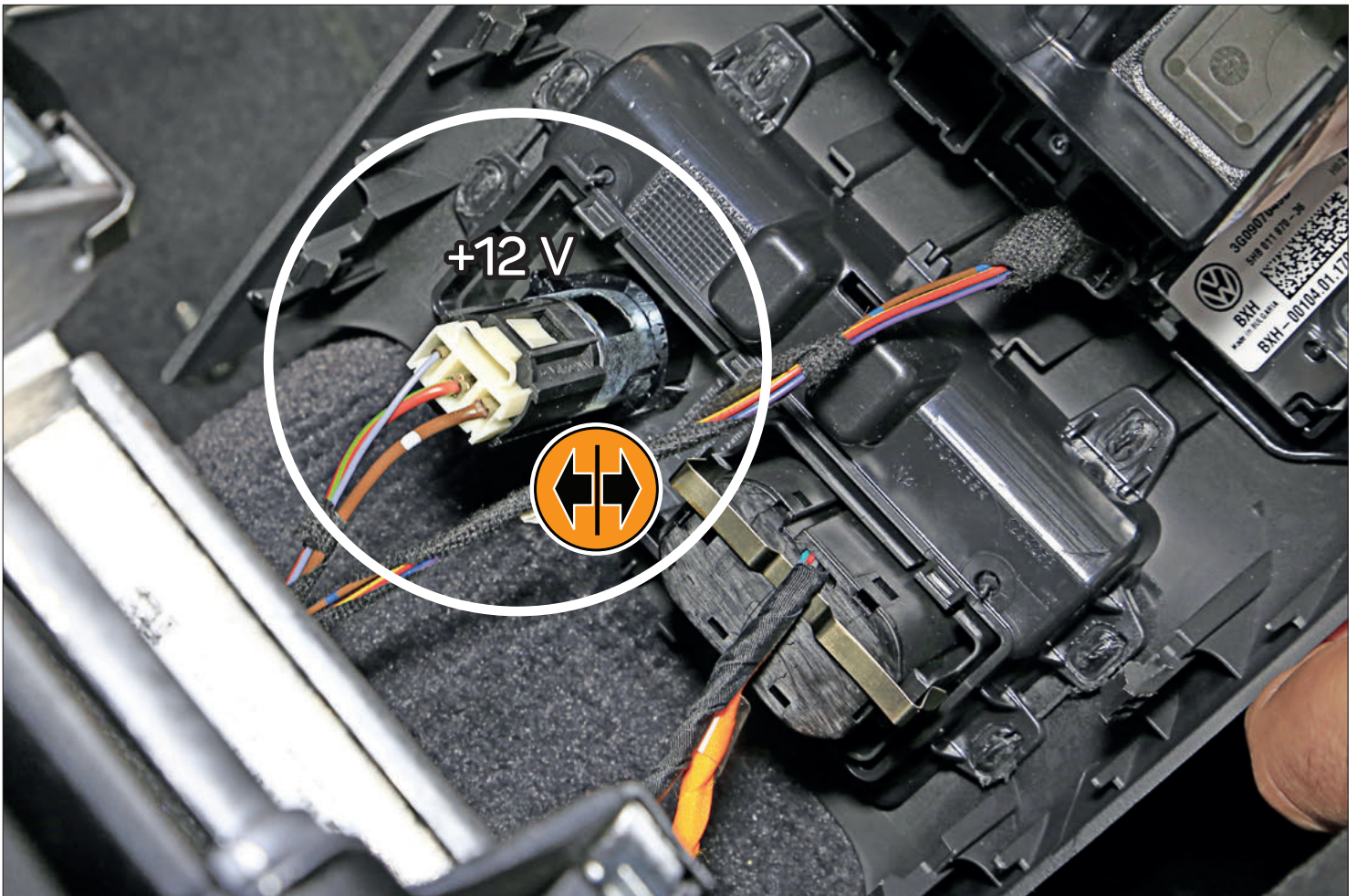

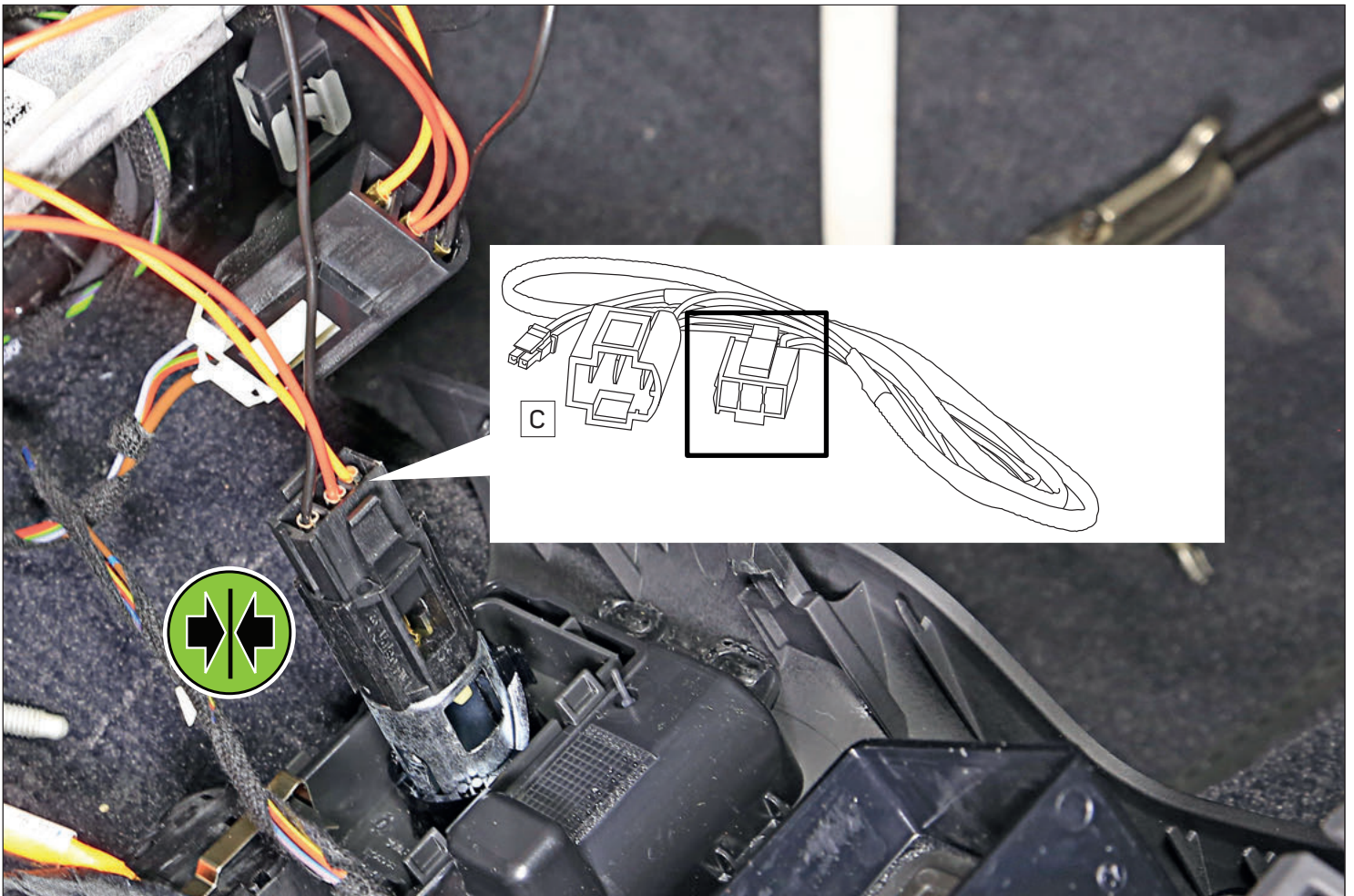
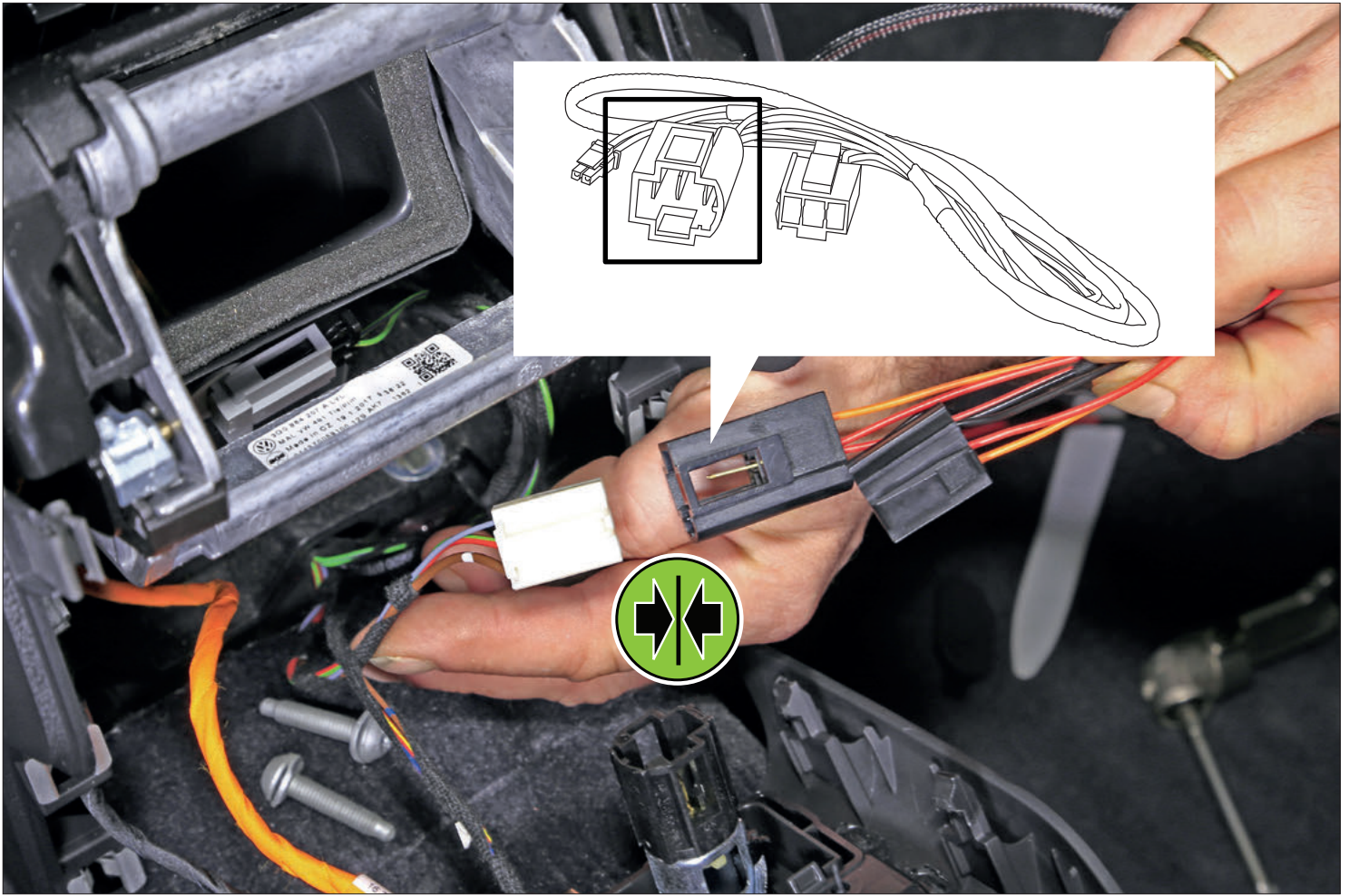

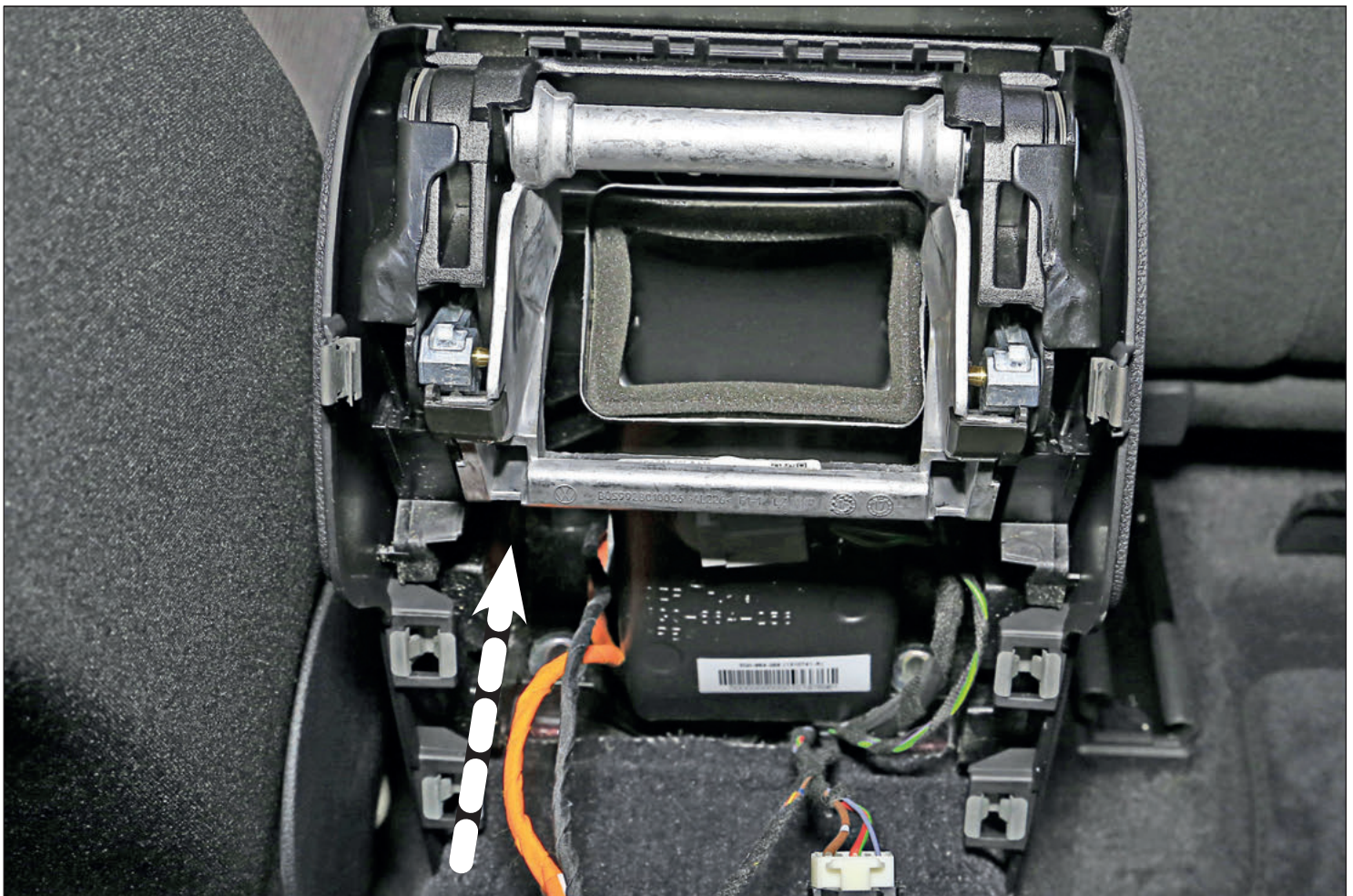
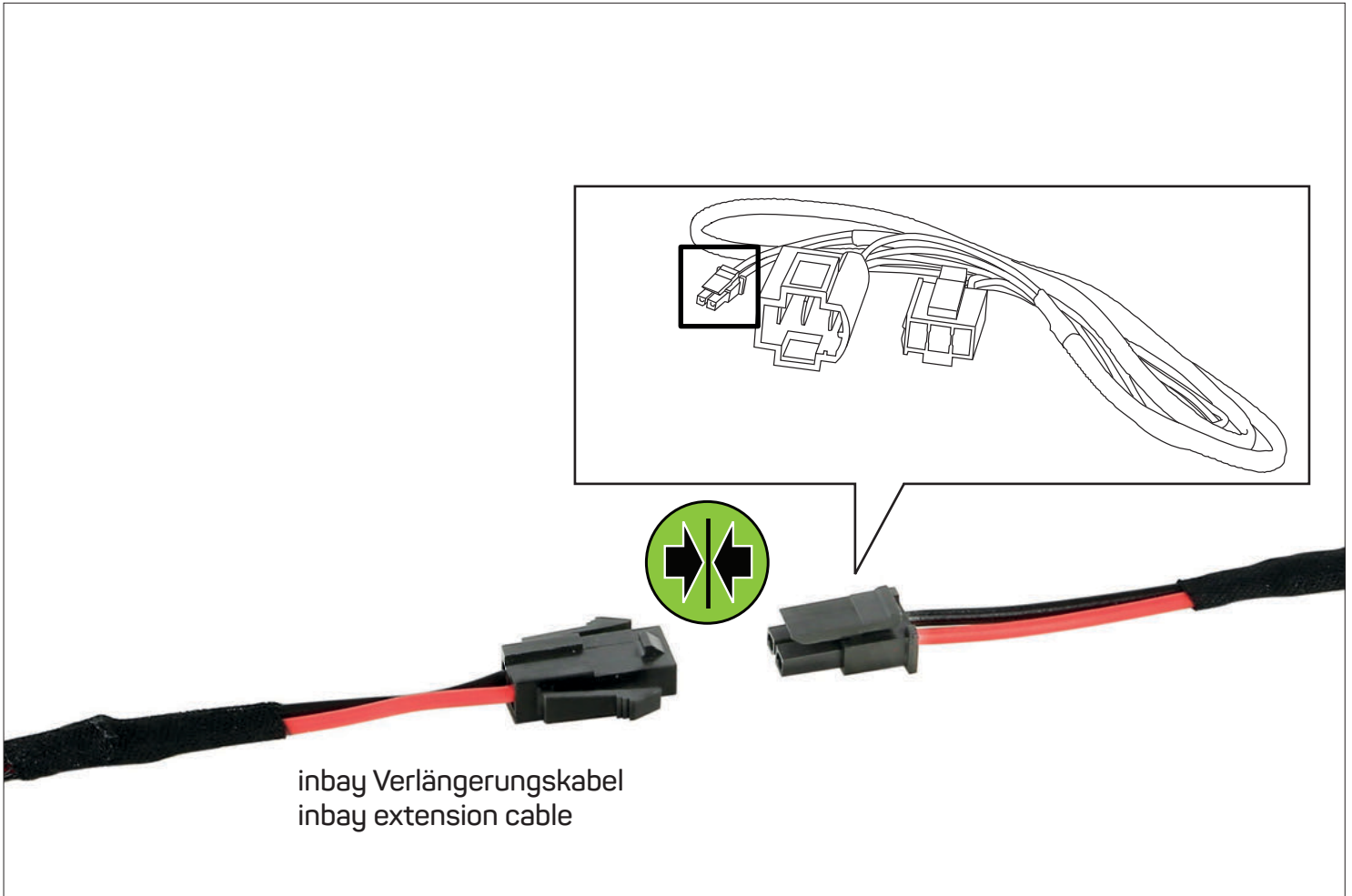





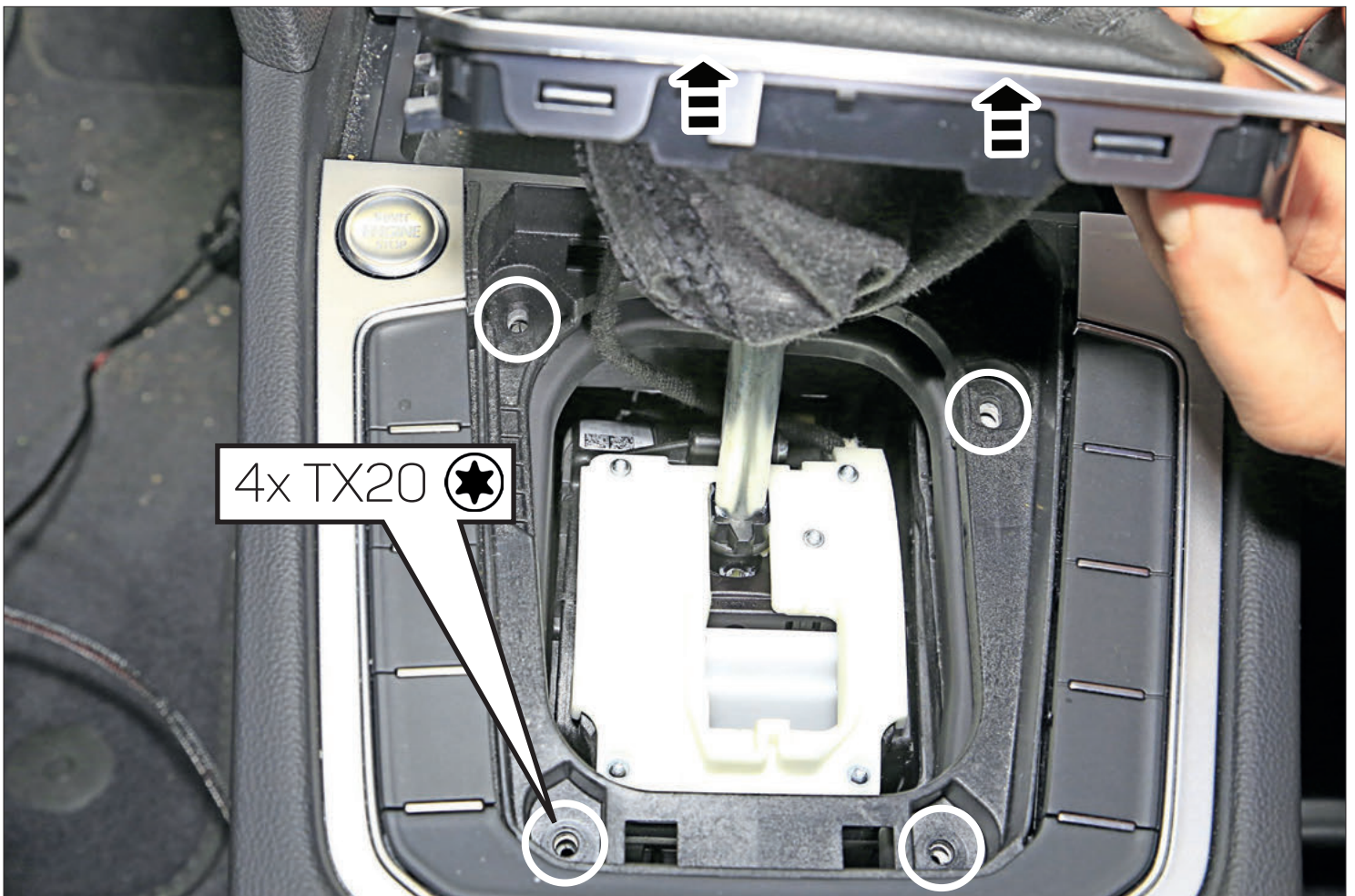



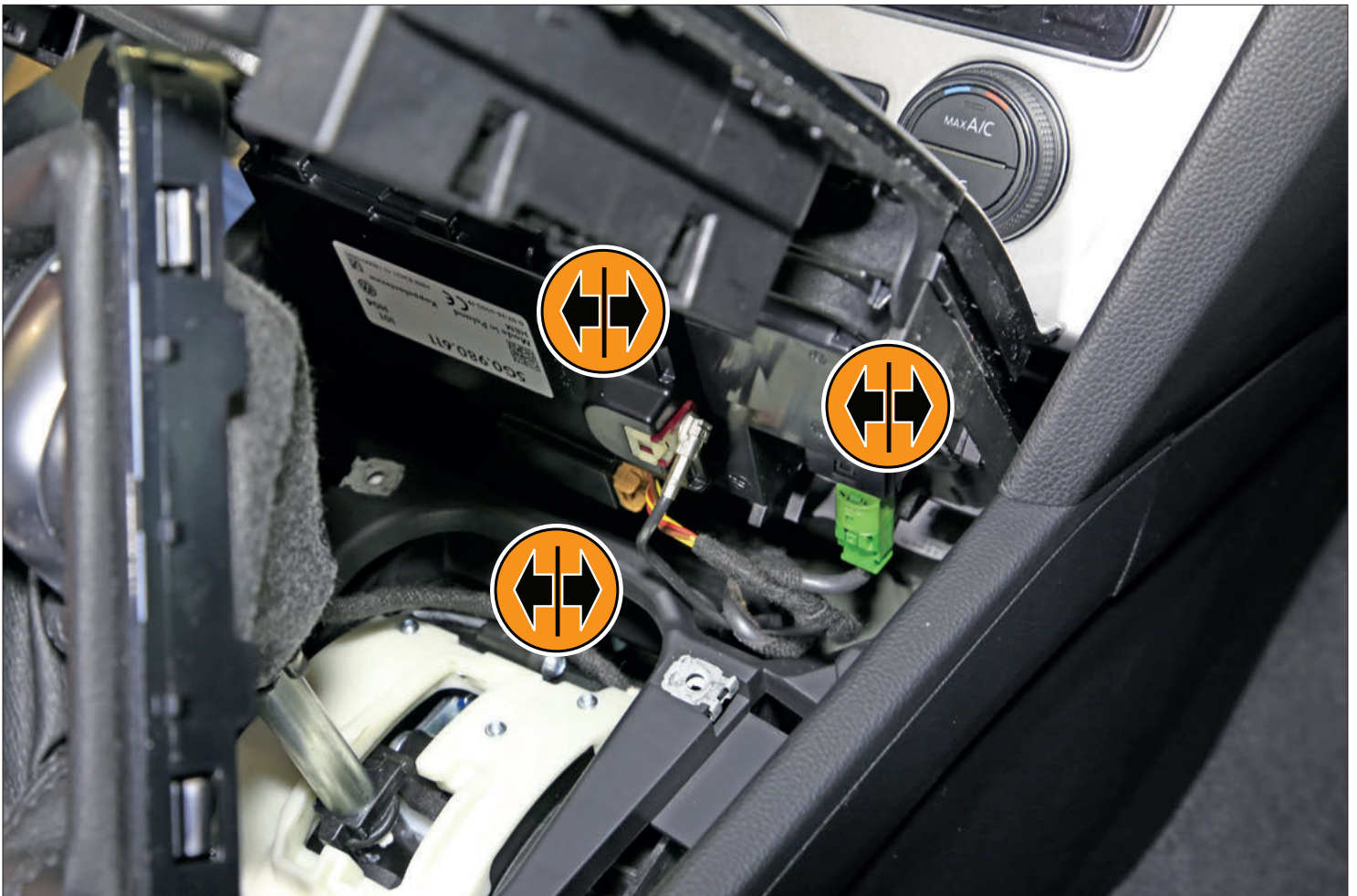

Kabelverlegung (wie bis Seite 11 beschrieben)
Hier weiterführen:

cablE installation (as described until page 11)
Please continue installation here:

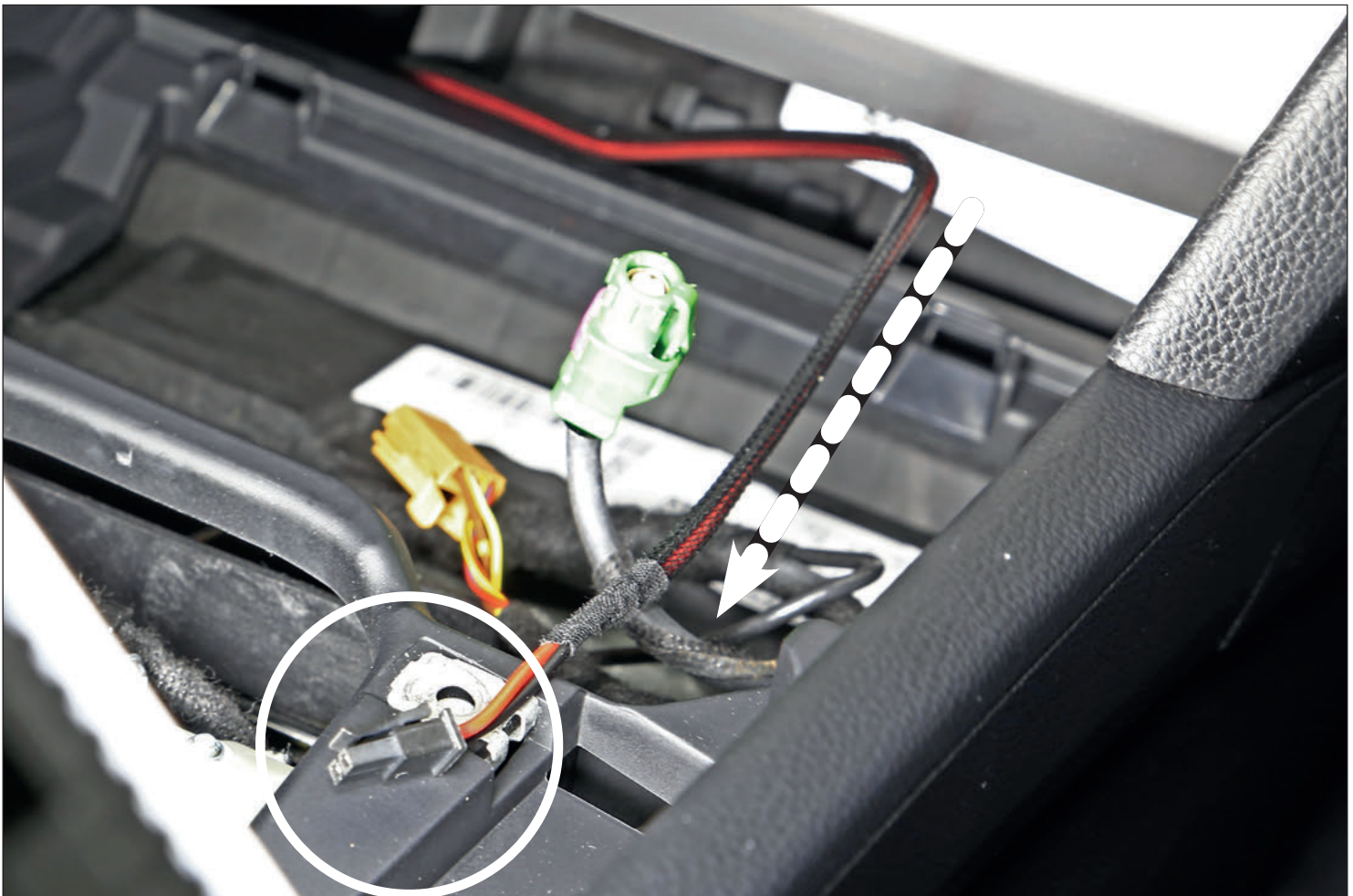

Zur weiteren Montage muss der Boden des originalen VW Passat Ablagefachs demontiert und durch unsere Ladeeinheit ersetzt werden. Dasselbe gilt für die Antirutschmatte (siehe Beispielabbildung).

Aufgrund technischer Umstände entfällt der USB-Anschluss des Ablagefachs.

The bottom of the original VW Passat pocket has to be disassembled and replaced with our inbay charging unit for further installation. The same goes for the original anti skid mat. (see sample photos)

Due to technical circumstances the USB socket can not be retained.

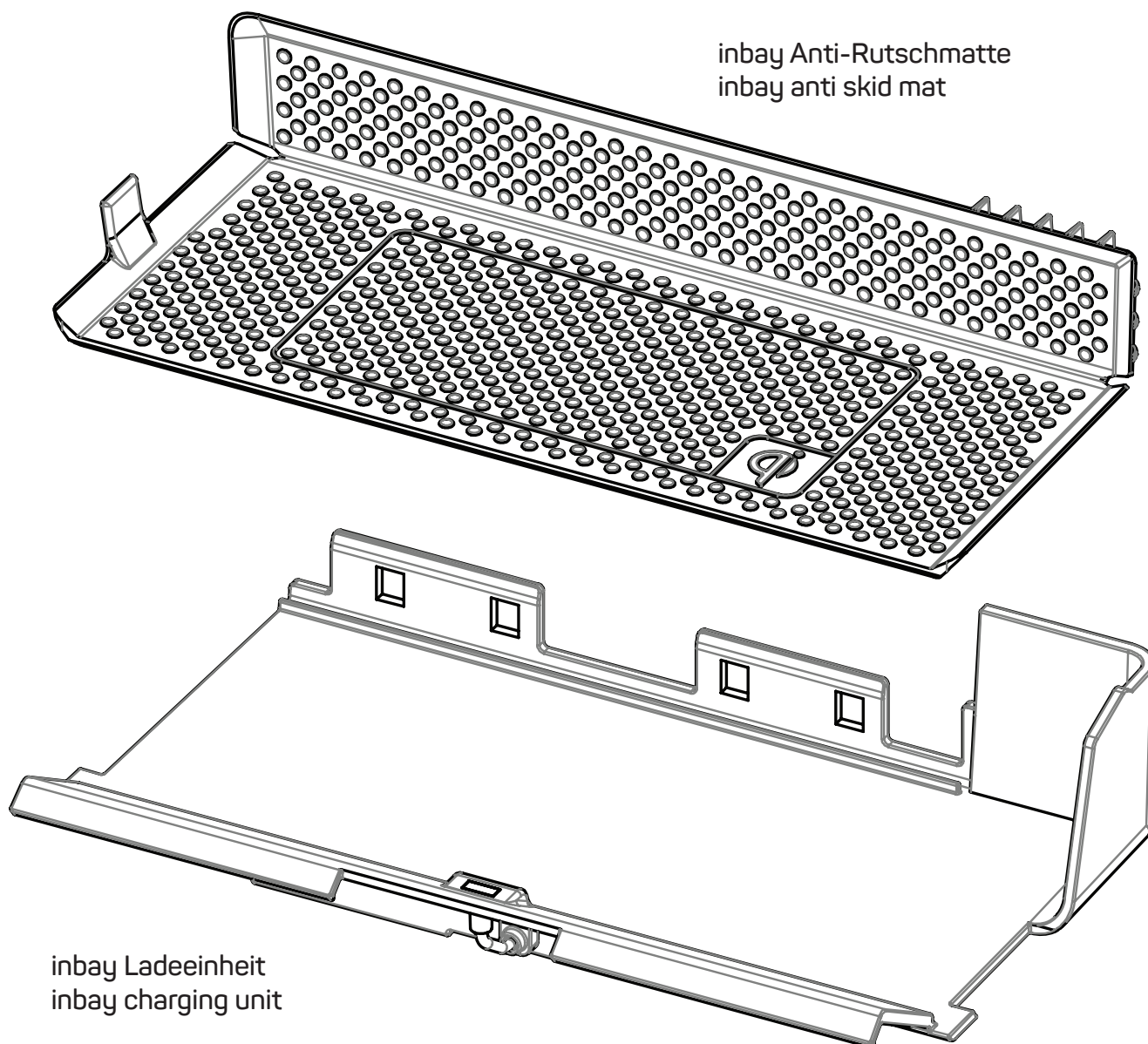

inbay Anti-Rutschmatte
inbay anti skid mat

inbay Ladeeinheit
inbay charging unit

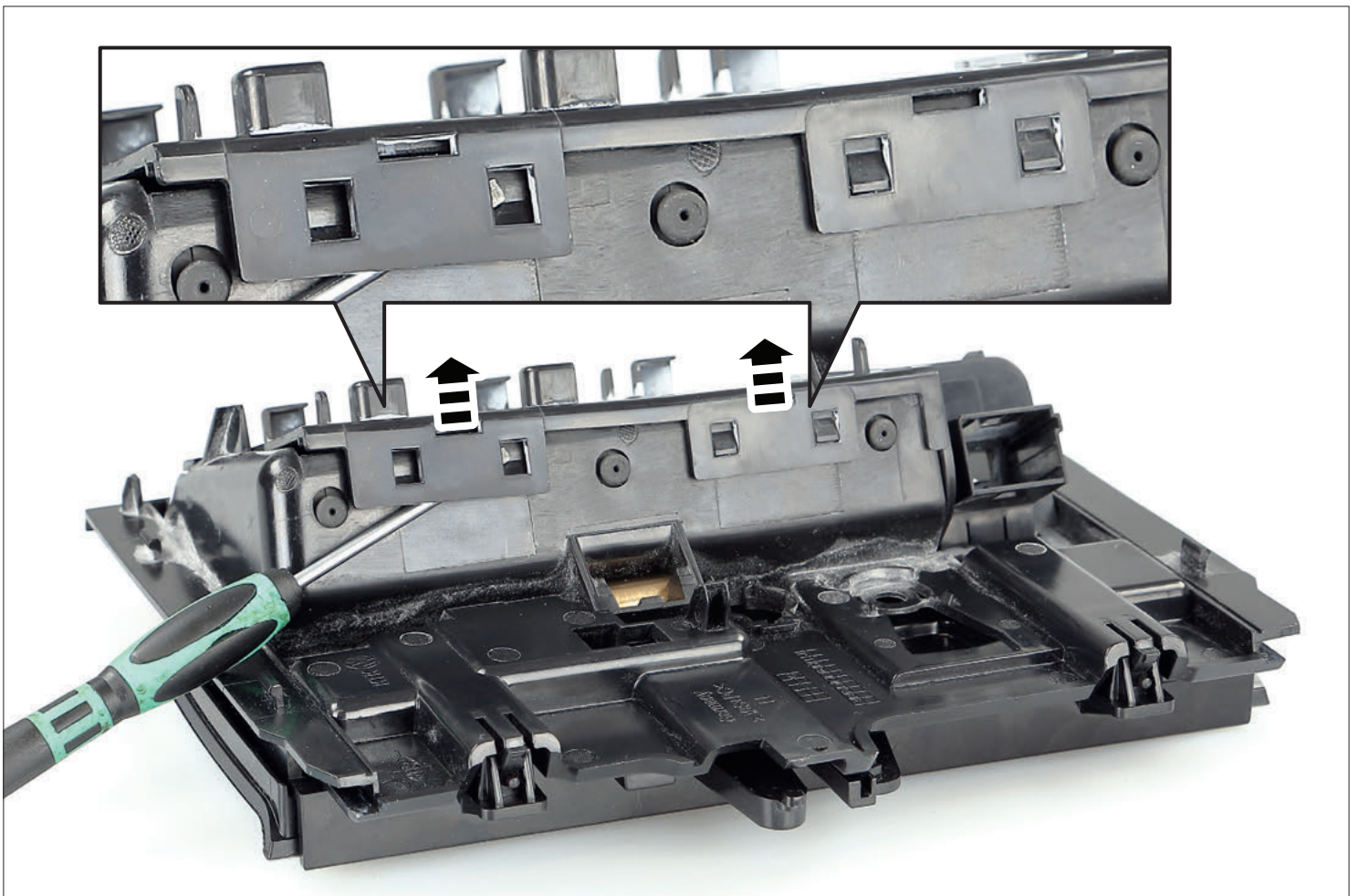

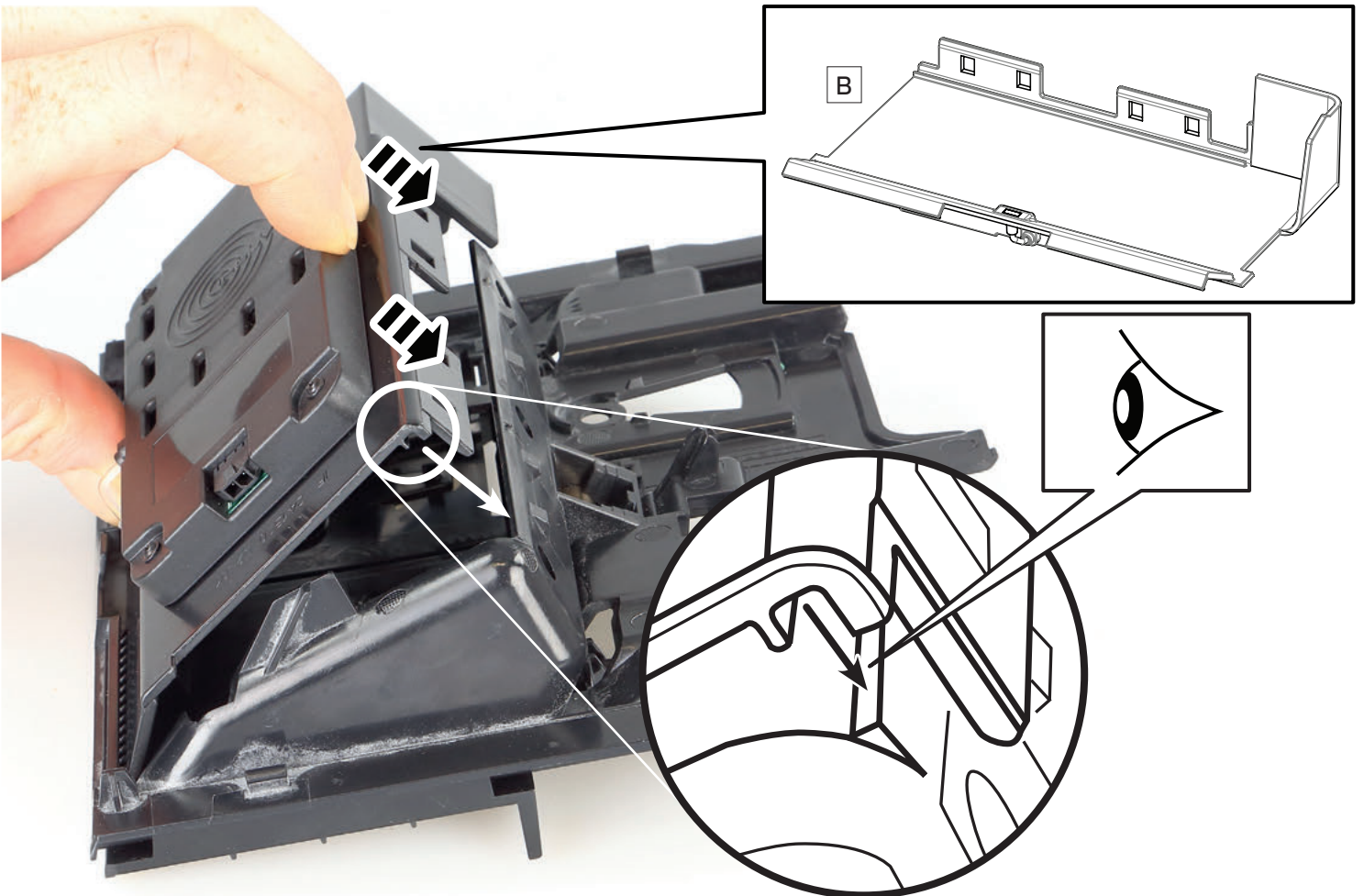
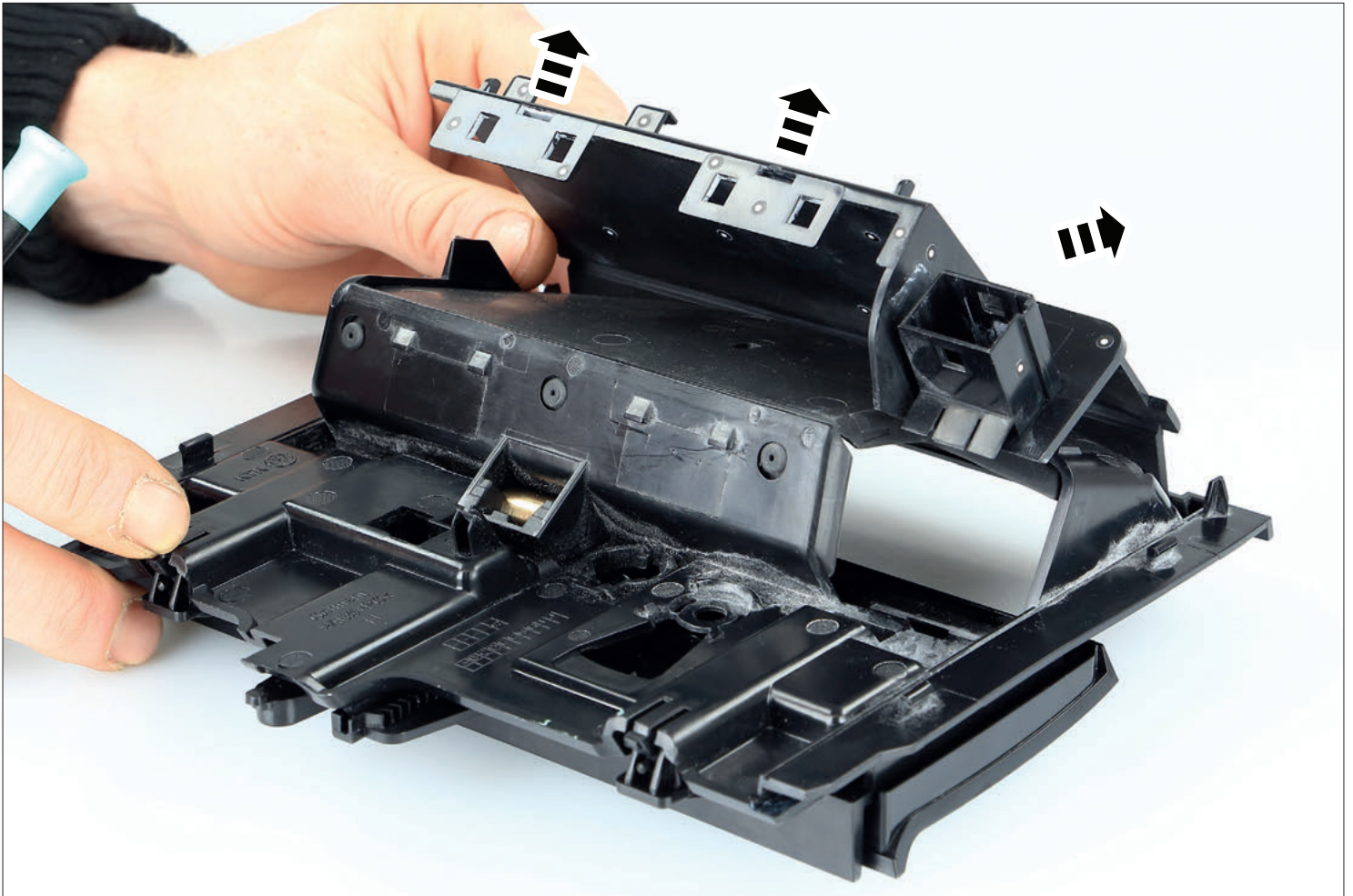

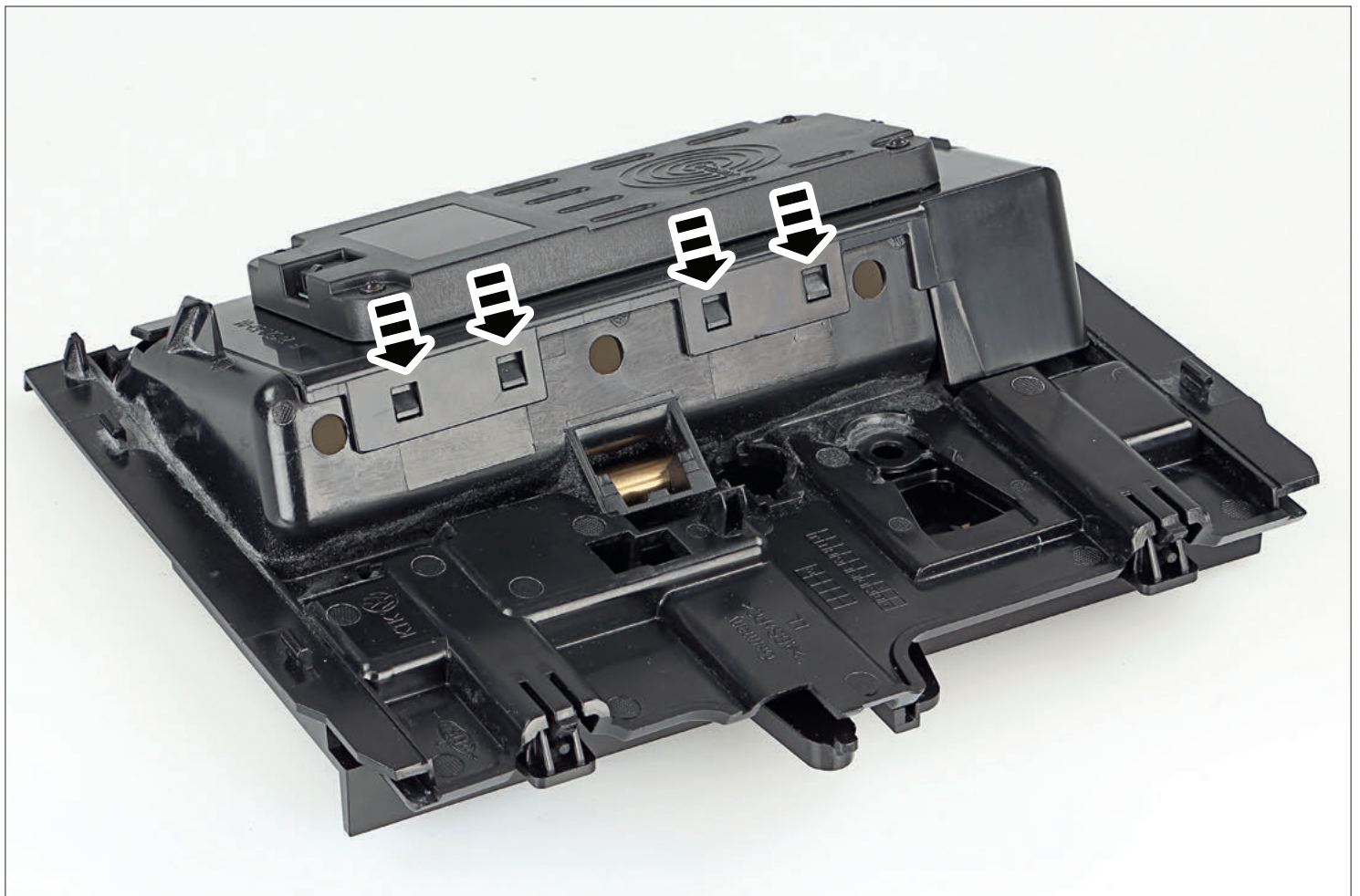

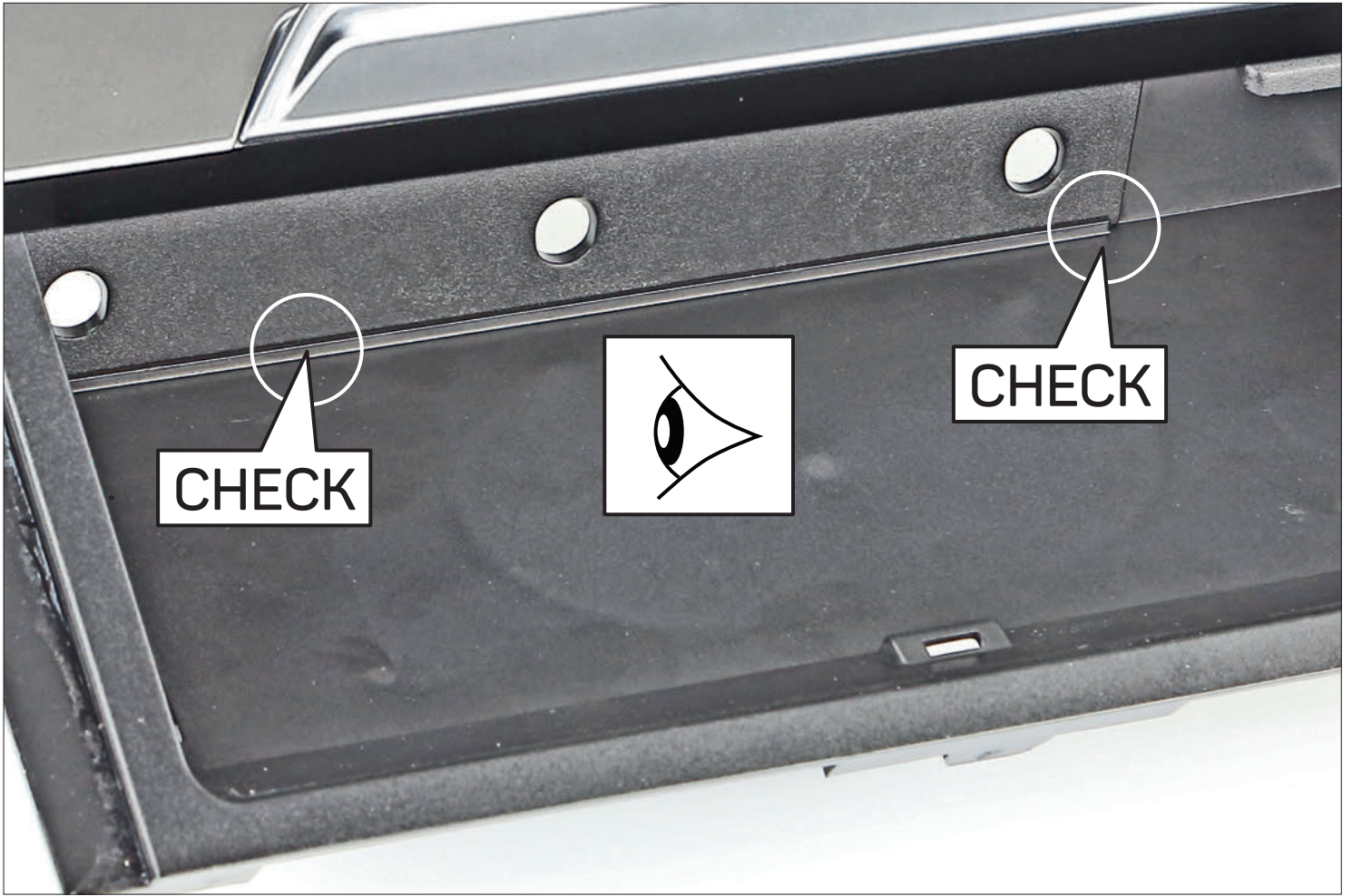

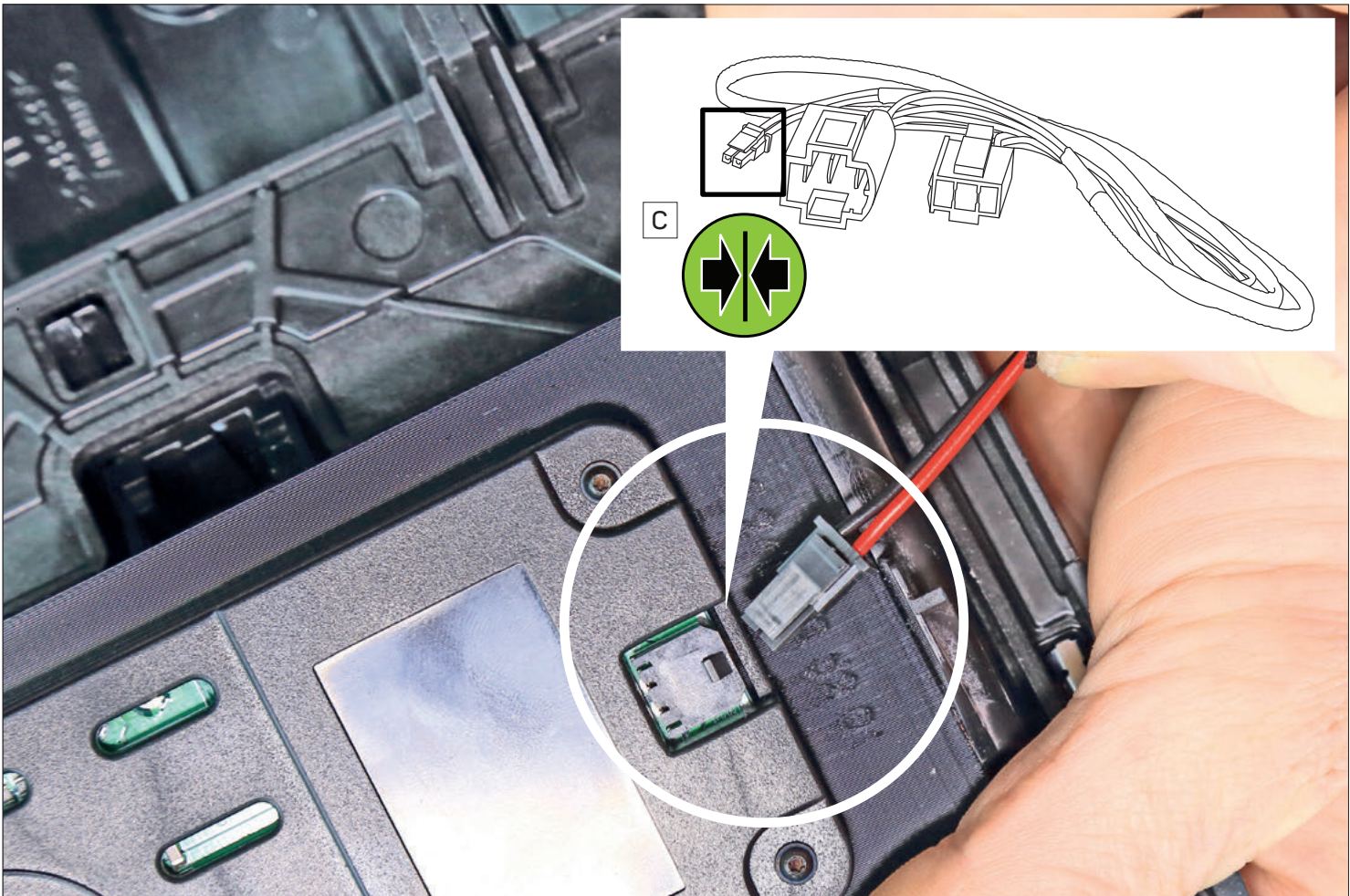
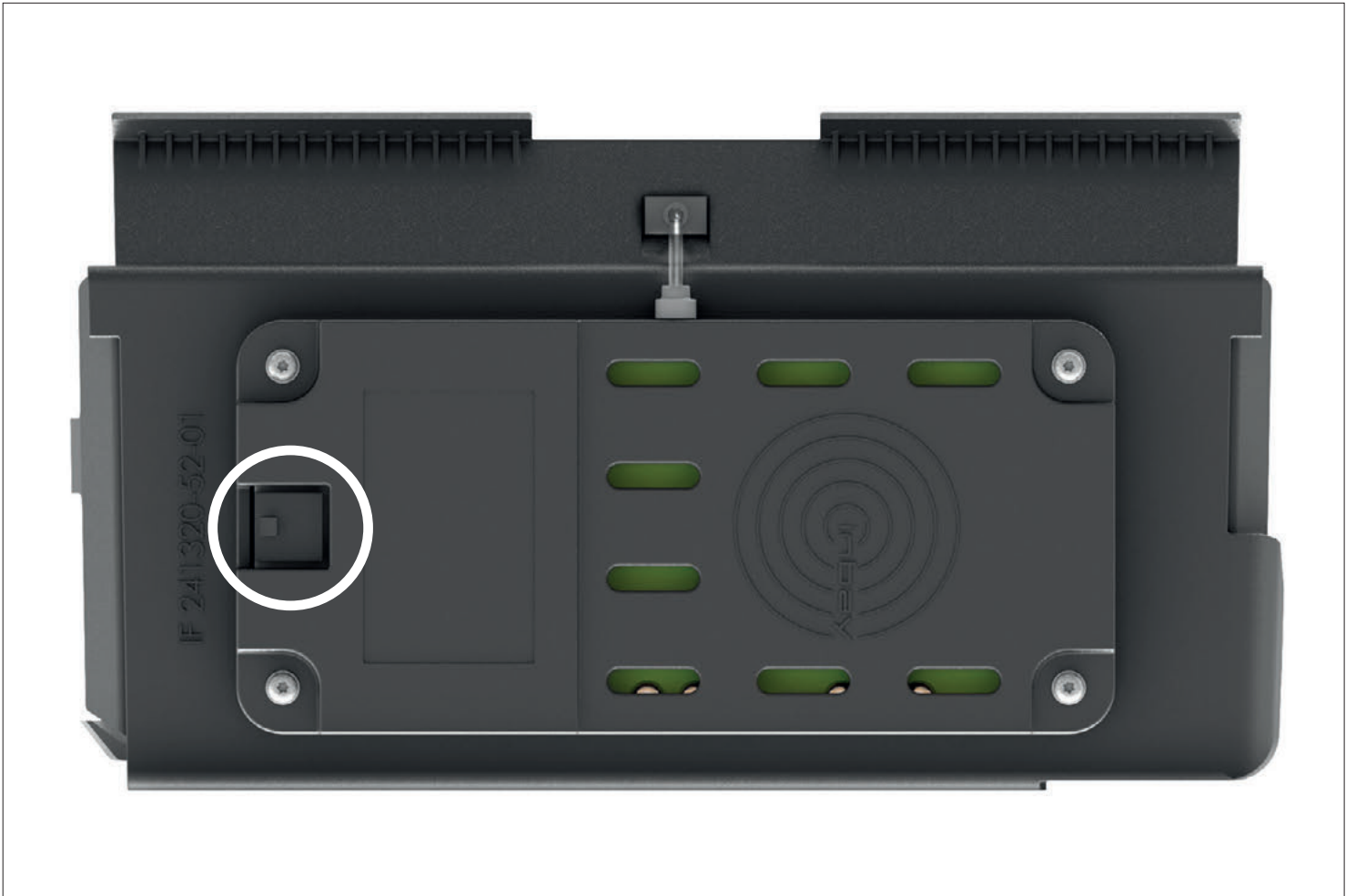

Setzen Sie das modifizierte Ablagefach in die Mittelkonsole und bauen Sie anschließend alles in umgekehrter Reihenfolge wieder zusammen.

Place the modified pocket into the center console and reinstall everything in reverse order to finish installation.



Blaue LED
Blue LED



Rote LED
Red LED



Falls Ihr Fahrzeug keine +12V Buchse unterhalb der Lüftungskonsole für die Fondpassagiere besitzt, muss die +12V Buchse der Mittelkonsole zur Stromversorgung genutzt werden.

If your vehicle is not equipped with a +12 V socket underneath the air vent console for rear seat passengers you have to use the +12 V socket on the center console for power supply.

OEM +12V Buchse
OEM +12V socket

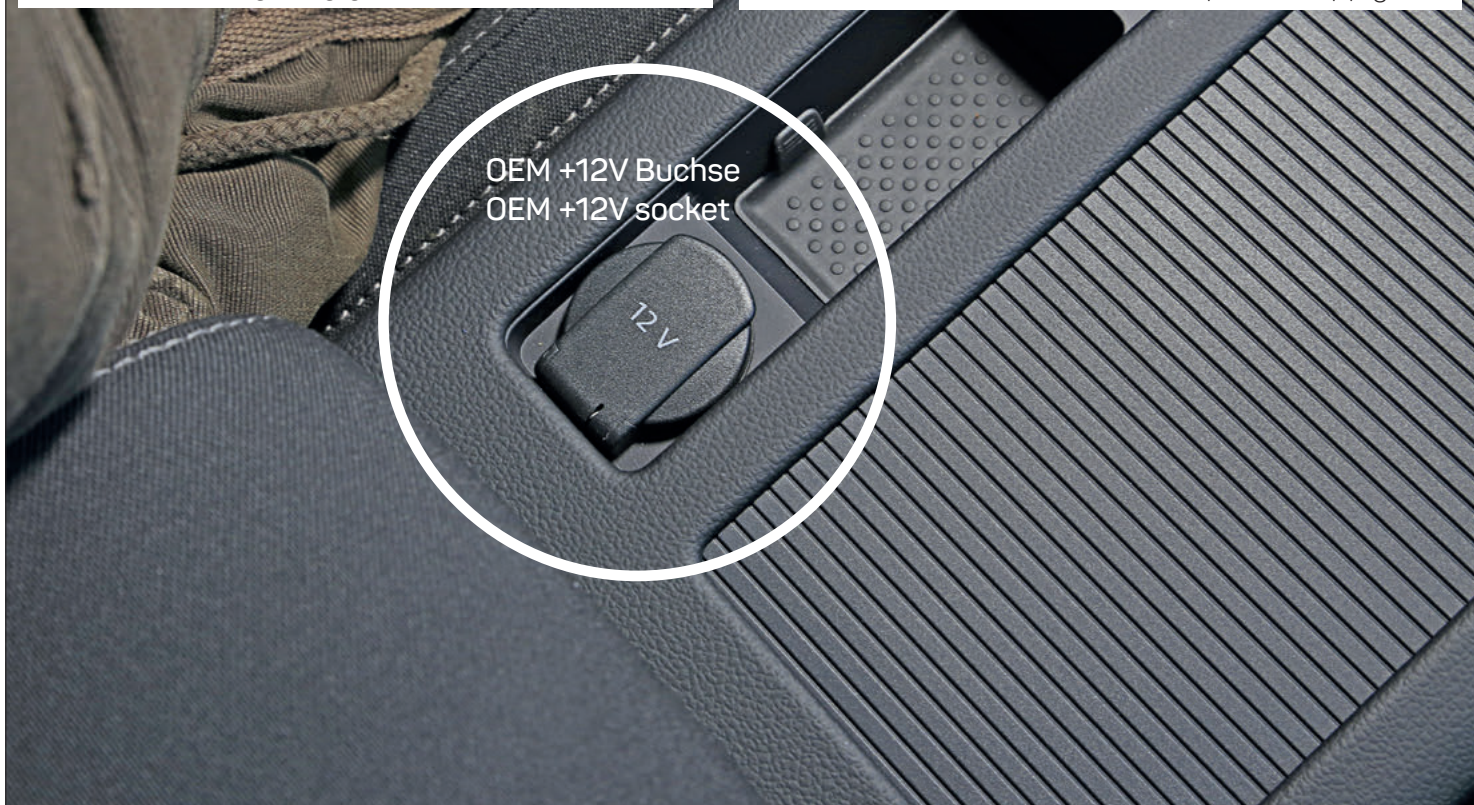

Ziehen Sie den Stecker von der +12 V Buchse ab. Diese befindet sich unter der Mittelkonsole.

Unplug the plug of the +12 V socket which is located underneath the center console.

Verbinden Sie die +12 V Buchse mit dem Stecker des inbay Y-Kabels. Verbinden Sie anschließend den Original Stecker mit der Buchse des inbay Y-Kabels.

Connect the +12 V socket with the plug of the inbay branch cable. Afterwards connect the original plug with the socket of the inbay branch cable.

inbay Y-Kabel / inbay branch cable

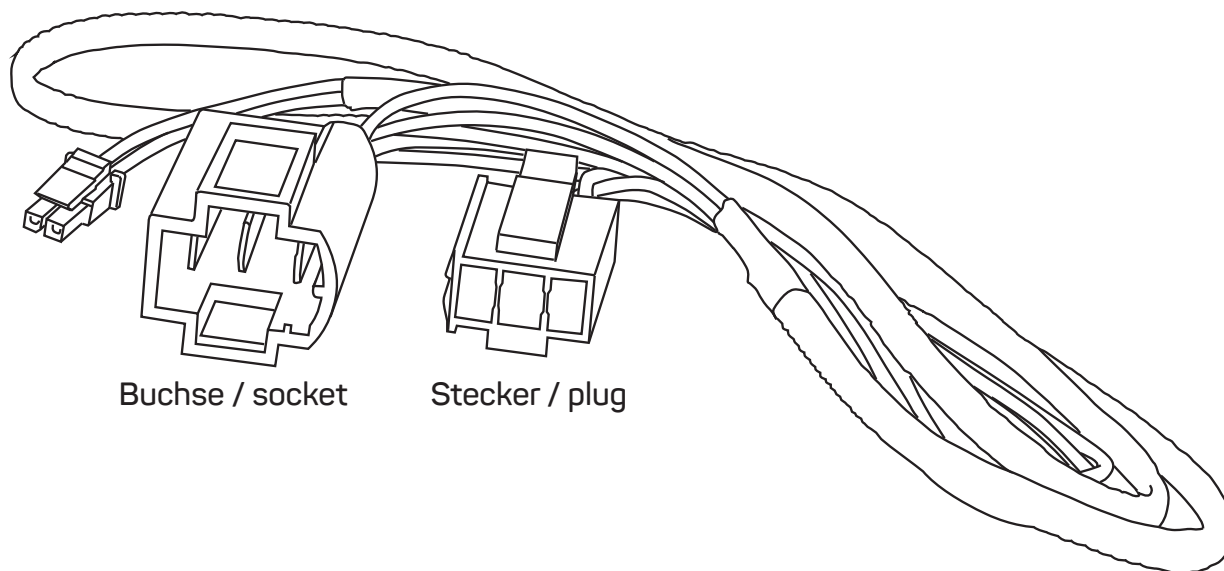

Weiter auf Seite 12 ff.
Go to page 12 ff.

