

Nabíjecí stanice pro bezdrátové nabíjení

8 70 343-1 Výkon 10W

8 70 343-2 Výkon 15W

INBAY

WIRELESS CHARGING

VW Arteon · Golf Sportsvan · Passat · Polo
T-Cross · T-Roc · Taigo · Tiguan II

STRANA PAGE	AUTOMOBIL/VEHICLE	LEVOSTRANÉ / LEFT-HAND-DRIVE	PRAVOSTRANÉ / RIGHT-HAND-DRIVE
		GUMOVÁ PODLOŽKA SE SYMBOLEM BEZDRÁTOVÉHO NABÍJENÍ (VOLITELNĚ) RUBBER MAT WITH WIRELESS CHARGING ICON (OPTIONAL) / VW ORIGINAL PART NO.	
4-13	VW Arteon (3H) Facelift 11/2020>	3G1 863 416 D	-
14-21	VW Golf Sportsvan (5G) Facelift 10/2017 - 06/2020	517 863 328 E	517 863 328 E
4-13	VW Passat (B8) Facelift 09/2019> / VW Passat Variant (B8) Facelift 09/2019>	3G1 863 416 D	-
22-29	VW Polo (AW1) 11/2017 - 05/2021 / VW Polo (AW1) Facelift 09/2021> VW Taigo (C5) 10/2021> *(Je vyžadována také gumová podložka + montážní rám) *(Rubber mat + mounting frame required)	Požadované / required : 2G1 863 330 B Montážní rámeček / Mounting Frame: 2G1 864 981 A	Požadované / required : 2G2 863 330 B Montážní rámeček / Mounting Frame: 2G2 864 981 A
30-37	VW T-Cross (C1) 04/2019>	2GM 863 330 A	2GM 863 330 A
38-46	VW T-Roc (A1) 01/2019 - 10/2021 / VW T-Roc (A1) Facelift 01/2022> VW T-Roc Cabriolet (A1) 03/2020 - 10/2021 VW T-Roc Cabriolet Facelift (A1) 03/2022>	2GA 863 328 C	2GB 863 328 B
48-72	VW Tiguan II 2016> / VW Tiguan II (Facelift) 2020> VW Tiguan Allspace 2017> / VW Tiguan Allspace (Facelift) Vozidla bez otvoru pro bezdrátové nabíjení vyžadují novou OEM středovou konzoli Číslo dílu VW: 5NB 863 241 F xxx / X = různé OEM barvy, příklad: 82V titanová černá Vehicles with closed tray require a new OEM center console VW part-no.: 5NB 863 241 F xxx / X = different OEM colours, example: 82V titan black	5NB 863 330 A Allspace: 5NN 863 330 A	5NC 863 330 C Allspace: 5NM 863 330 B

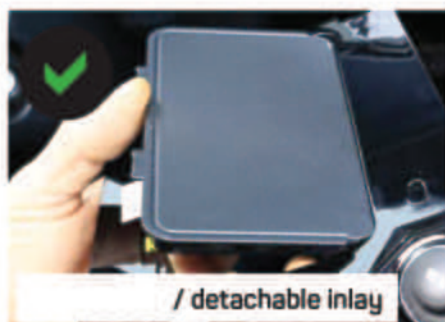

/ detachable inlay

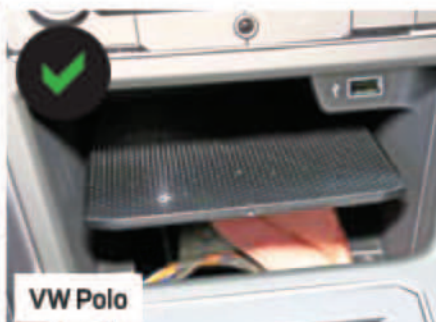

VW Polo



Modely VW s jedním kusem vestavěná police pod gumovou podložkou bohužel nejsou kompatibilní.

VW models with a one-piece solid storage shelf below the rubber mat are not compatible.

POZOR! Před instalací prosím zkontrolujte zda je váš VW vybaven odnímatelnou vložkou pod pryžovou podložkou — toto neplatí pro Modely VW Polo, pro tyto montážní rám (Č. dílu: 2G1 864 981 A - viz seznam) musí objednat samostatně.

ATTENTION! Before installation, please check if your VW is equipped with a detachable inlay below the rubber mat — this is not applicable for VW Polo models, as for these an mounting frame (Part-no.: 2G1 864 981 A - see list) has to be ordered separately.

Při instalaci je nutné dodržení všech postupů dle tohoto návodu. Ujistěte se, že kabelové svazky jsou uspořádány tak, aby nebyla ohnuta nebo krimpované kvůli riziku poškození kabelů. Ujistěte se, že všechny konektory jsou správně zapojené. Vedte kabely mimo pohyblivé části a zajistěte, aby kabely nebyly zamotané, přiskřípnuté nebo jakkoli poškozené. Neneseme odpovědnost za škody způsobené nesprávnou instalací nebo používáním. Používejte specifikované příslušenství, abyste předešli selhání produktu. Technické změny vyhrazeny; nepřijímá se za žádná odpovědnost. Symbol „Qi“ je ochrannou známkou „Wireless Power Consortium“

An appropriate installation in observance of these operating instructions is necessary. Please make sure the wiring is arranged so it is not bended or crimped due to the risk of cable break. Make sure that all connections are correct. Route the cable away from moving parts, do not allow the cable to be entangled, pinched or damaged in any way. We will not be liable for damage due to improper installation or utilization. Use the specified accessory parts to prevent product failure. Subject to technical modifications; no responsibility is accepted for the accuracy of this information. The "Qi" symbol is a trademark of the "Wireless Power Consortium"

DETEKCE NEZNÁMÉHO PŘEDMĚTU (FOD)



DŮLEŽITÉ UPOZORNĚNÍ

Nepokládejte prosím žádné jiné předměty, jako jsou mince, kreditní karty atd. na INBAY nabíjecí podložku. **Zvláště smarphony s instalovaným kruhovým držákem na zadní straně nelze použít!** Integrovaná funkce "Detekce neznámých objektů" (FOD) přeruší bezdrátové nabíjení z bezpečnostních důvodů.

IMPORTANT INFORMATION:

Please don't place any other objects such as coins, credit cards etc. onto the INBAY surface. **Especially smartphones with attached ring stand holder must not be used!** - otherwise the integrated Foreign Object Detection (FOD) will interrupt wireless charging for safety reasons.

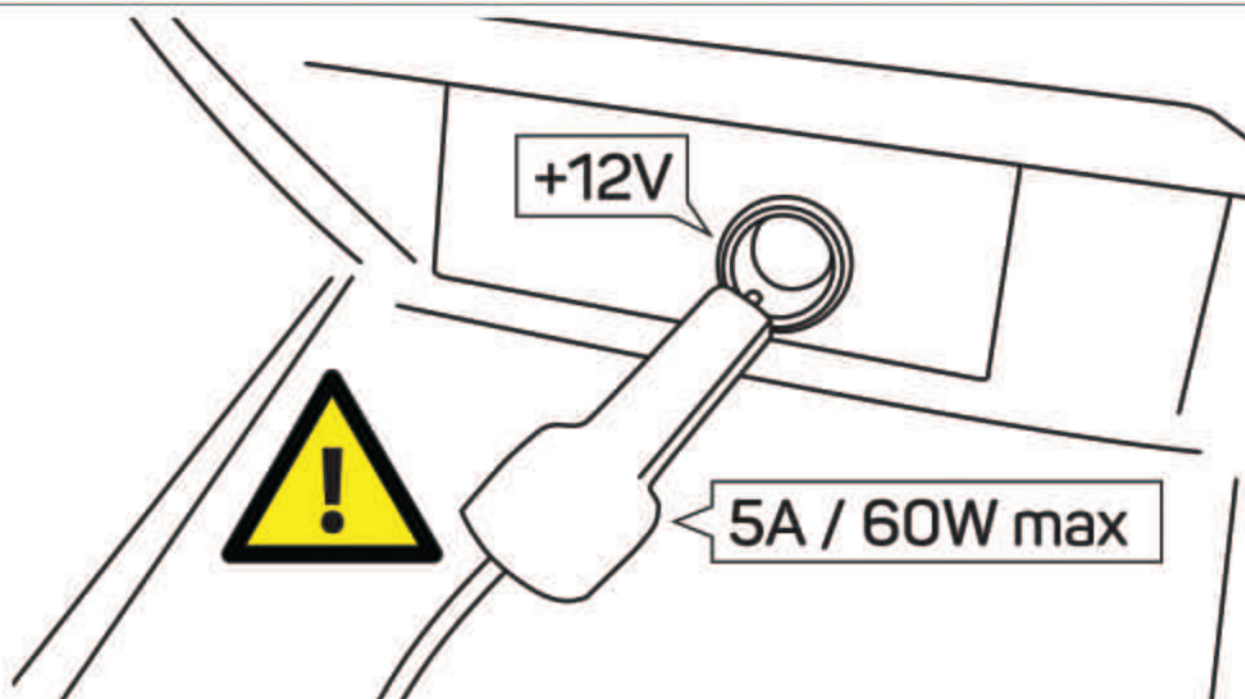
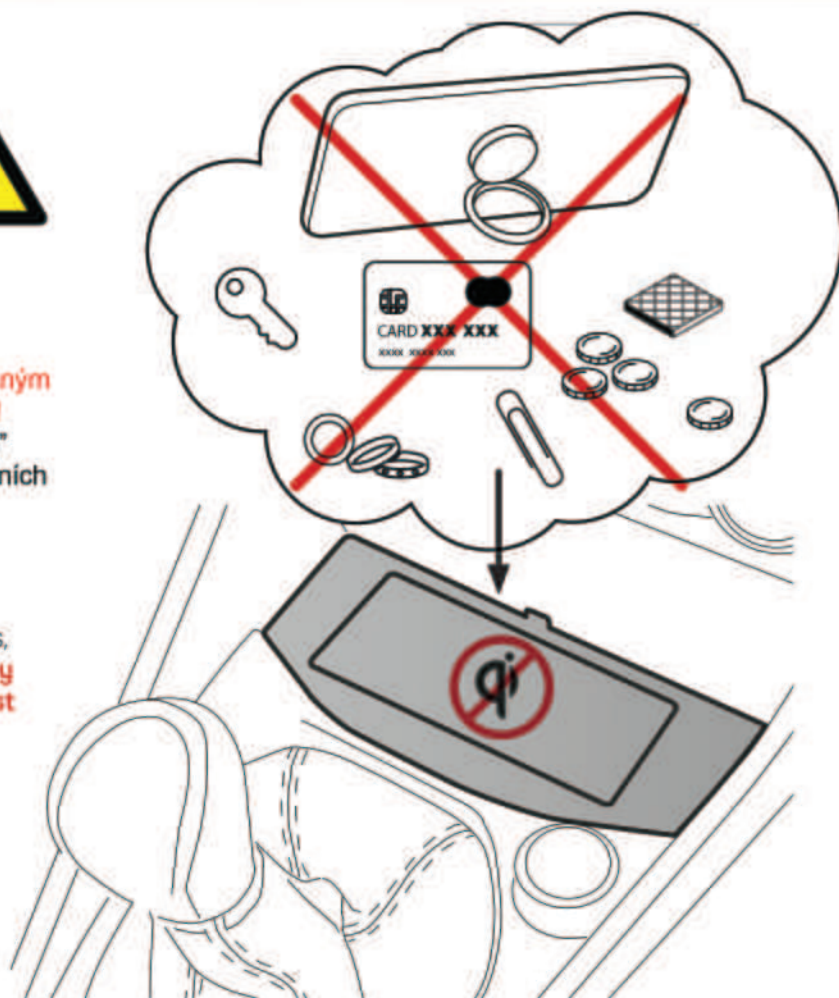

POZOR! Po instalaci nesmí být na zásuvce +12V provozována žádná zařízení/spotřebiče s více než **5A / 60W**, jinak hrozí přepětí!

ATTENTION! After installation, devices/consumers with more than **5A / 60W** shall not be operated on the +12V socket. Otherwise a risk of overvoltage can occur!

A

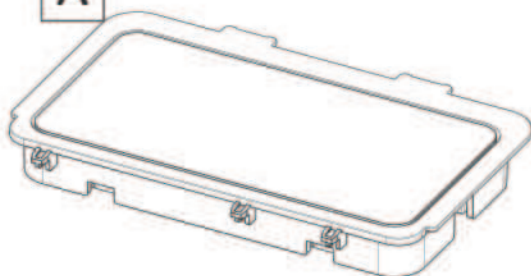

INBAY bezdrátový nabíjecí modul

B

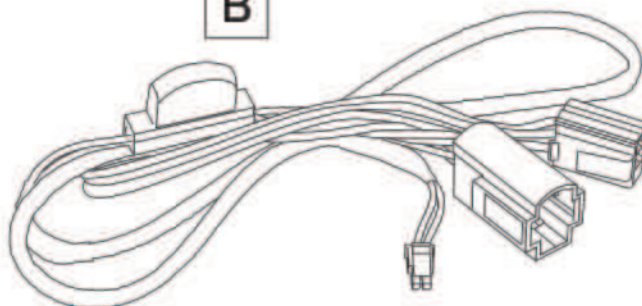

INBAY napájecí kabel

8 70 343-1 10W

Napájecí napětí	12V (DC)	
Výstupní napětí	5V	9V
Výstupní proud	1.1A	1.2A
Výstupní výkon	5W	10W

8 70 343-2 15W

12V (DC)		
5V	9V	9V
1.1A	1.2A	1.6A
5W	10W	15W

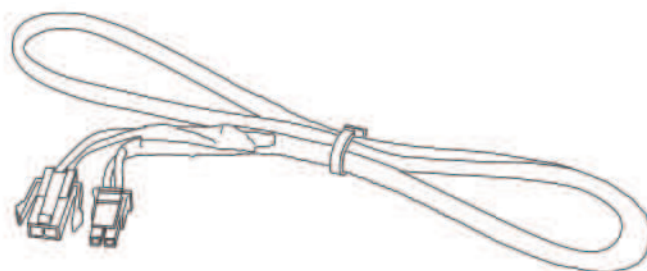

INBAY prodlužovací kabel

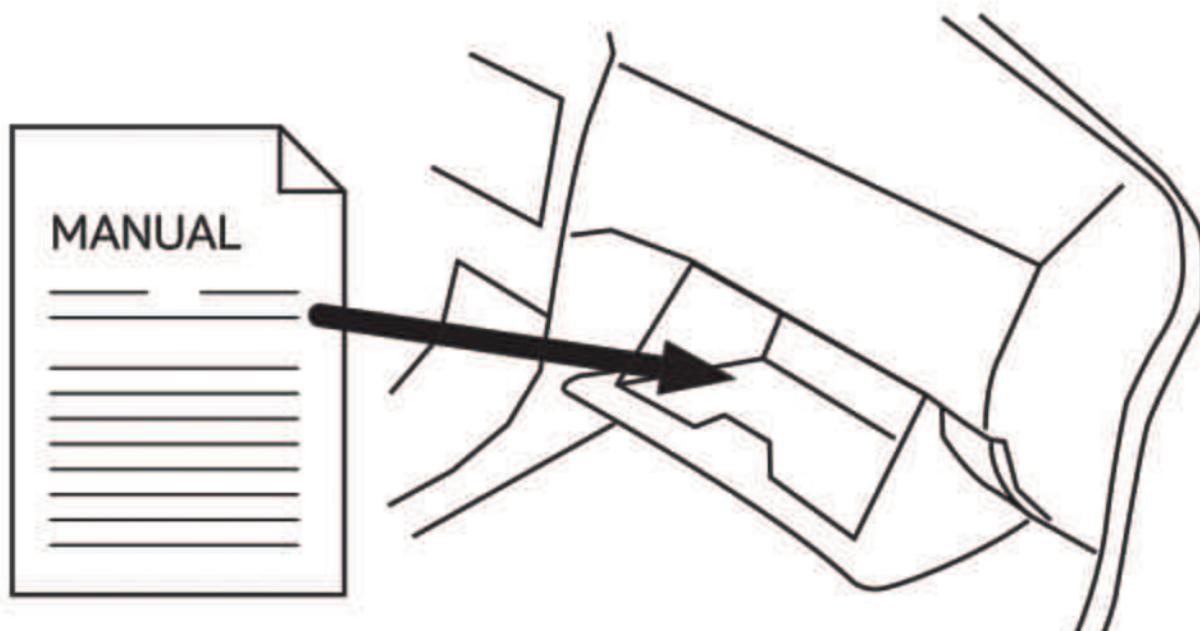

DŮLEŽITÉ! PO INSTALACI MUSÍ BÝT NÁVOD UMÍSTĚN DO PŘIHRÁDKY V PALUBNÍ DESCE VOZU ZÁKAZNÍKA.

IMPORTANT! AFTER INSTALLATION THE MANUAL HAS TO BE PLACED INTO THE DASH BOARD OF THE CUSTOMER'S CAR.

VW Arteon 2020



VW Passat / Passat Variant 2020

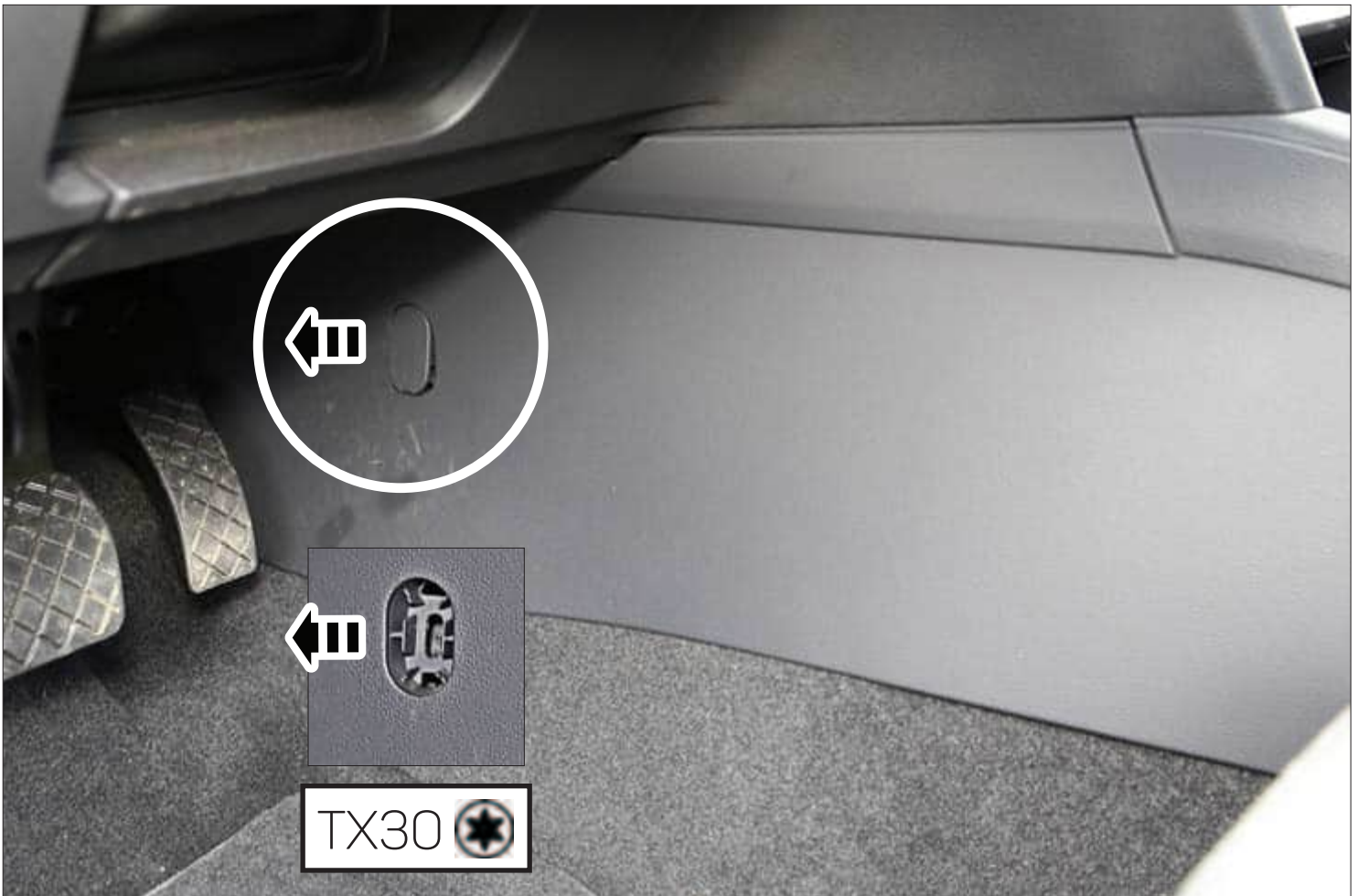

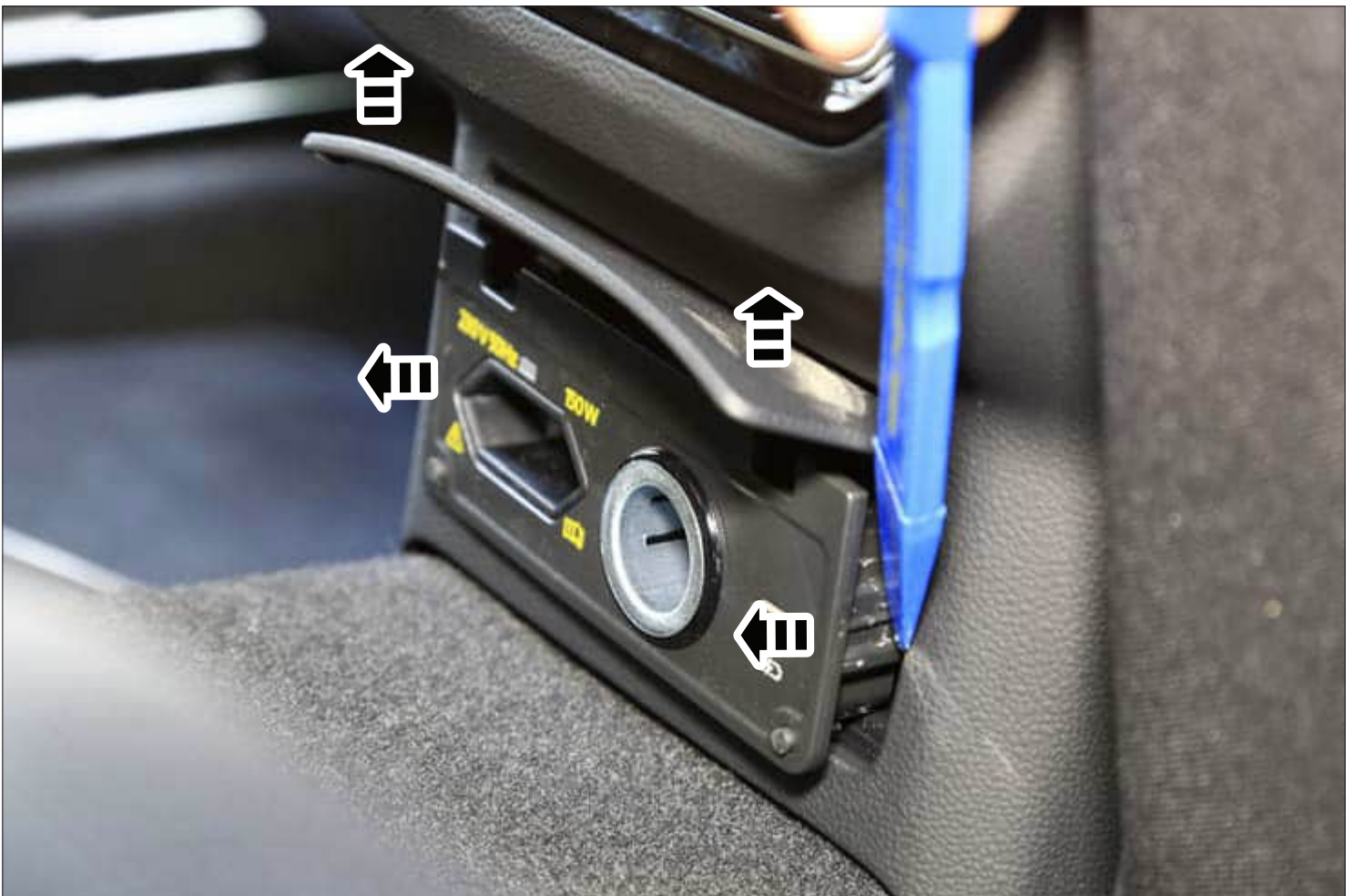

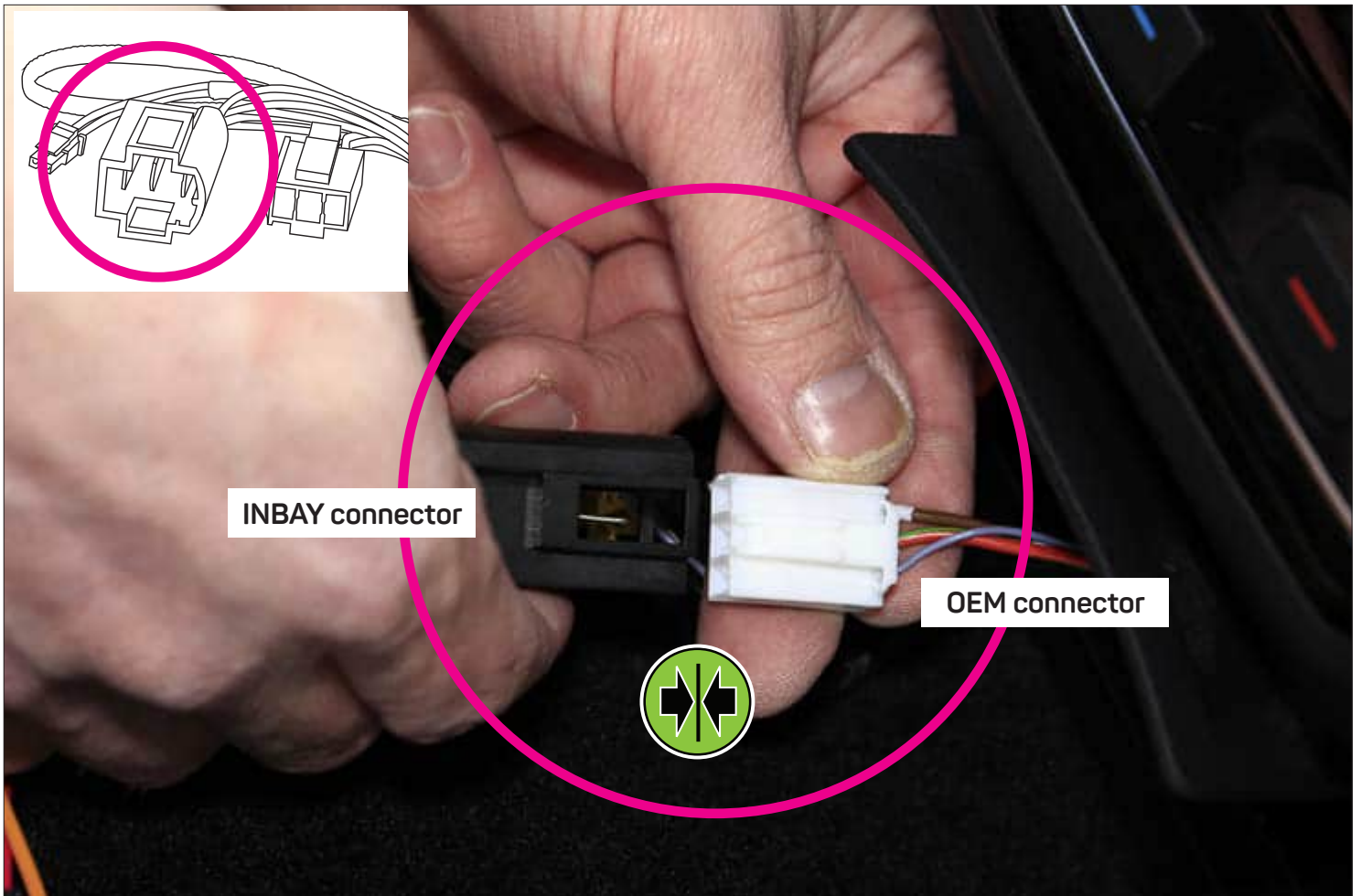
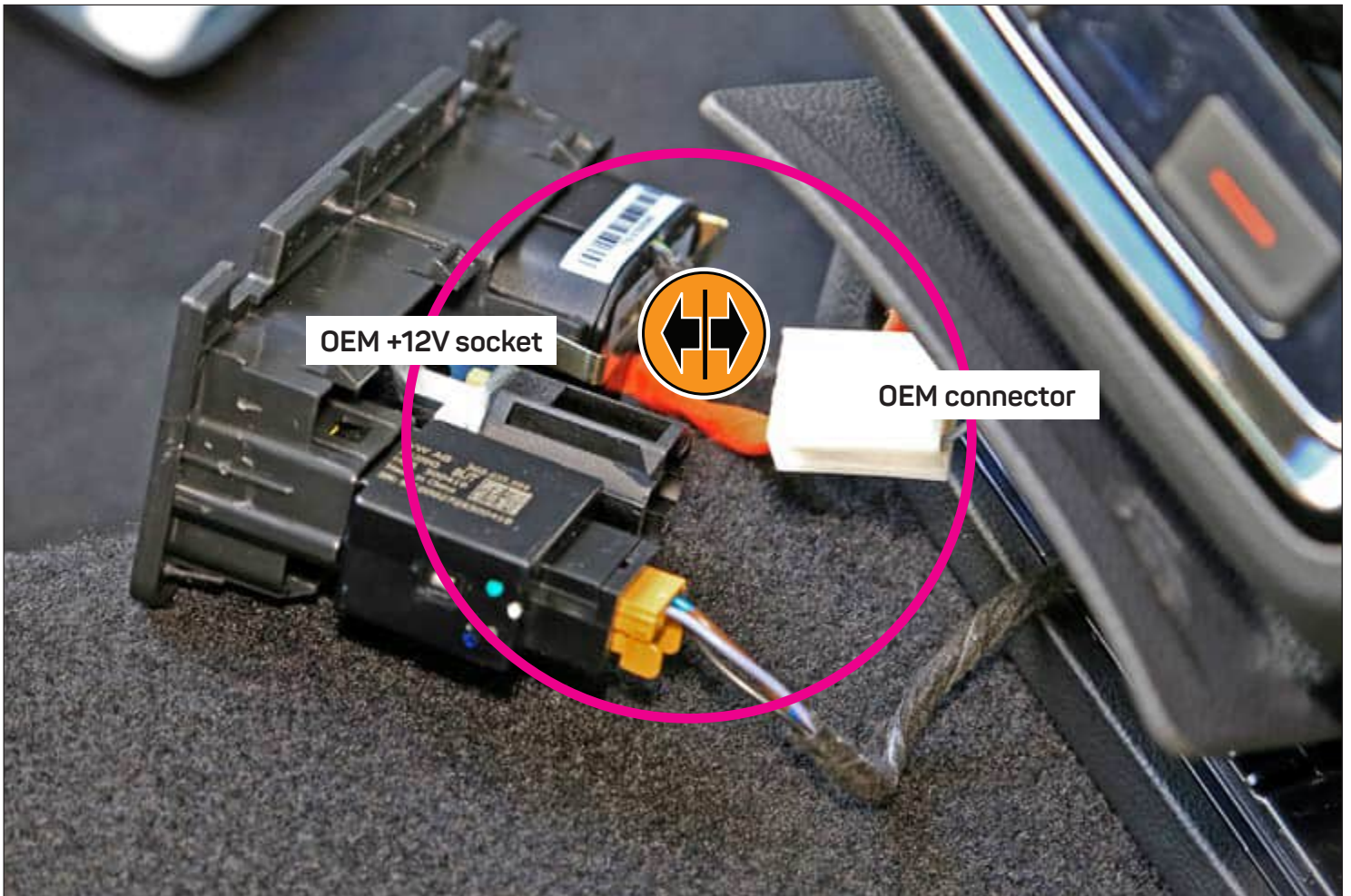

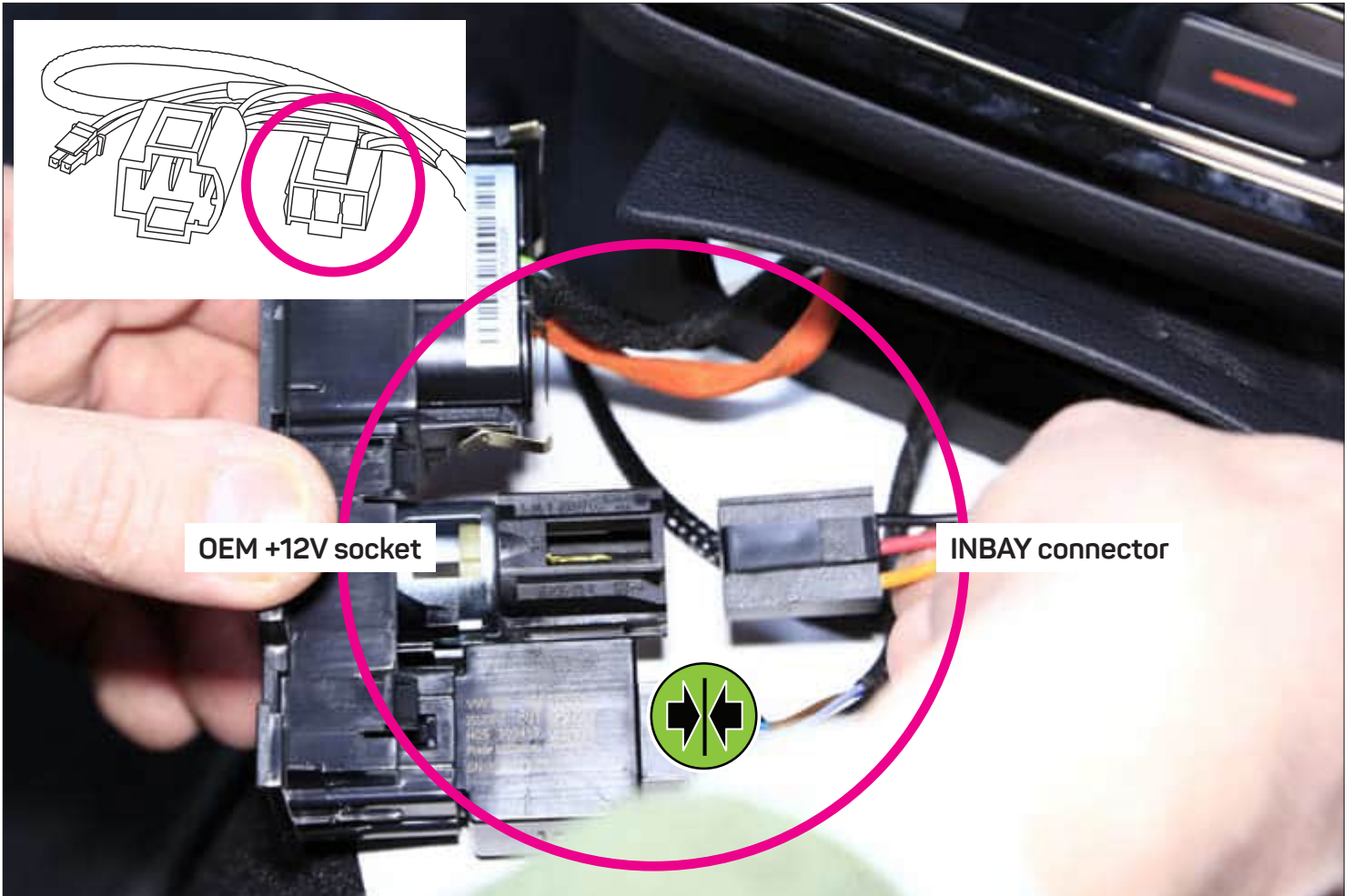

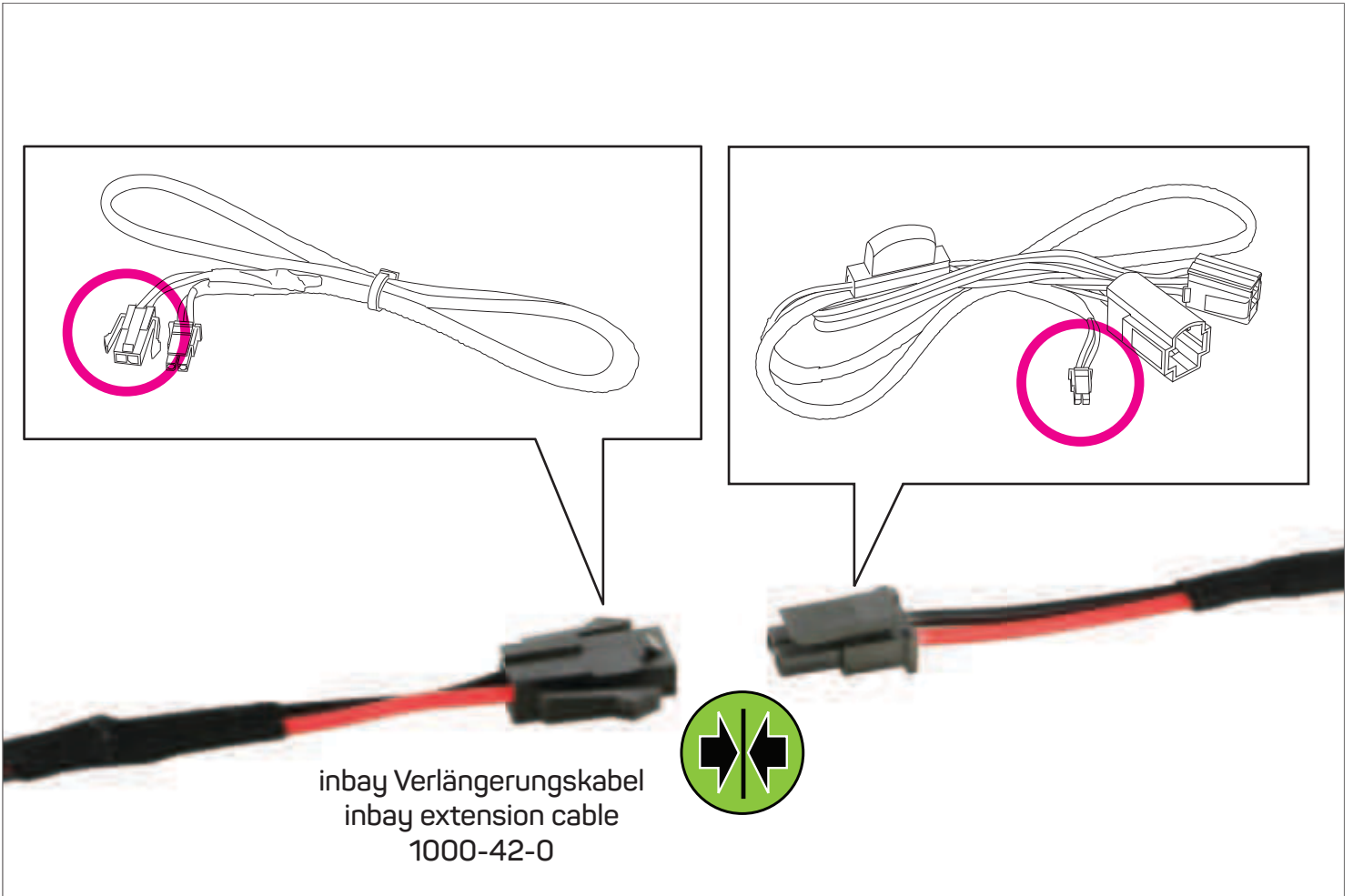

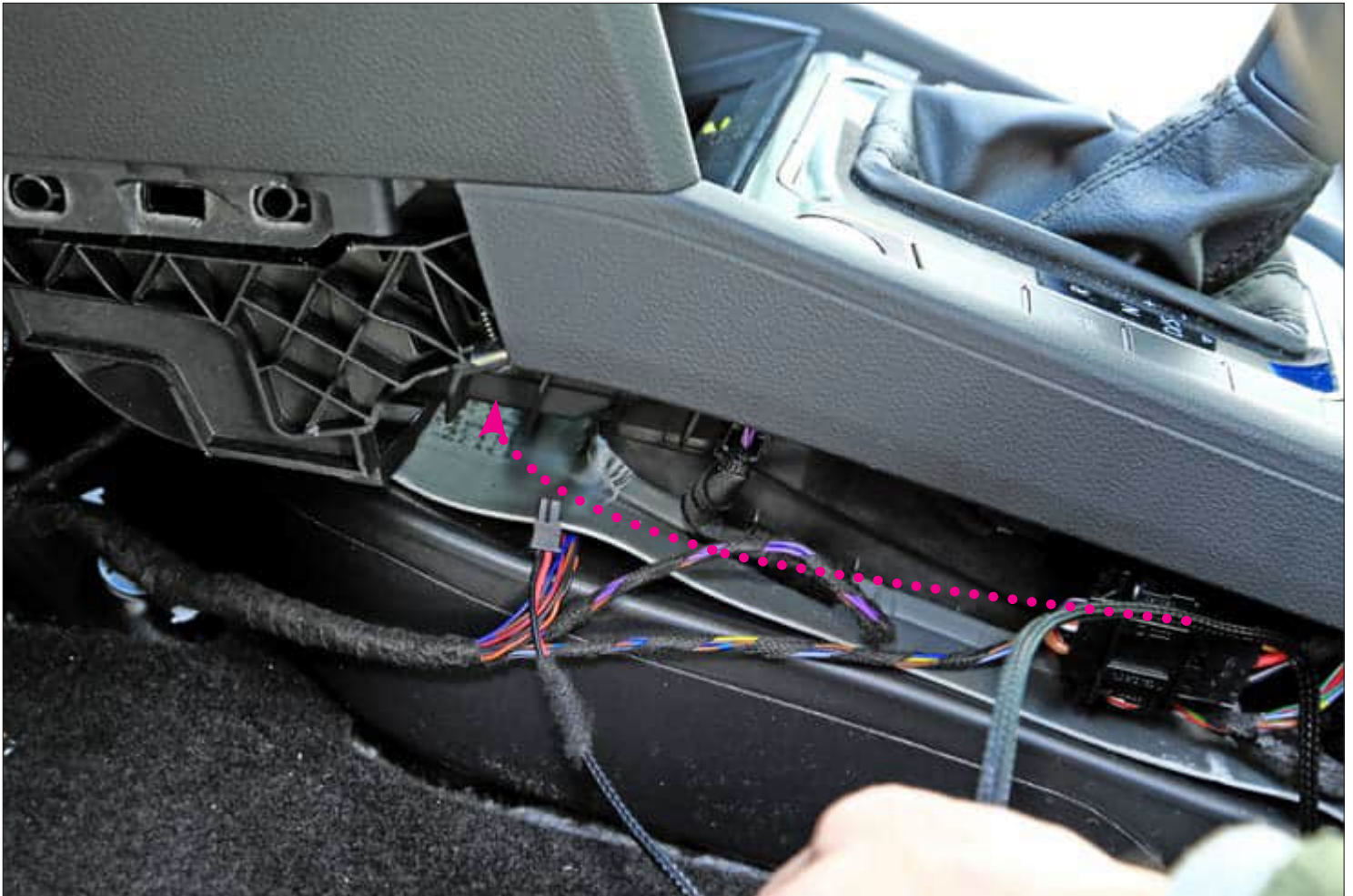



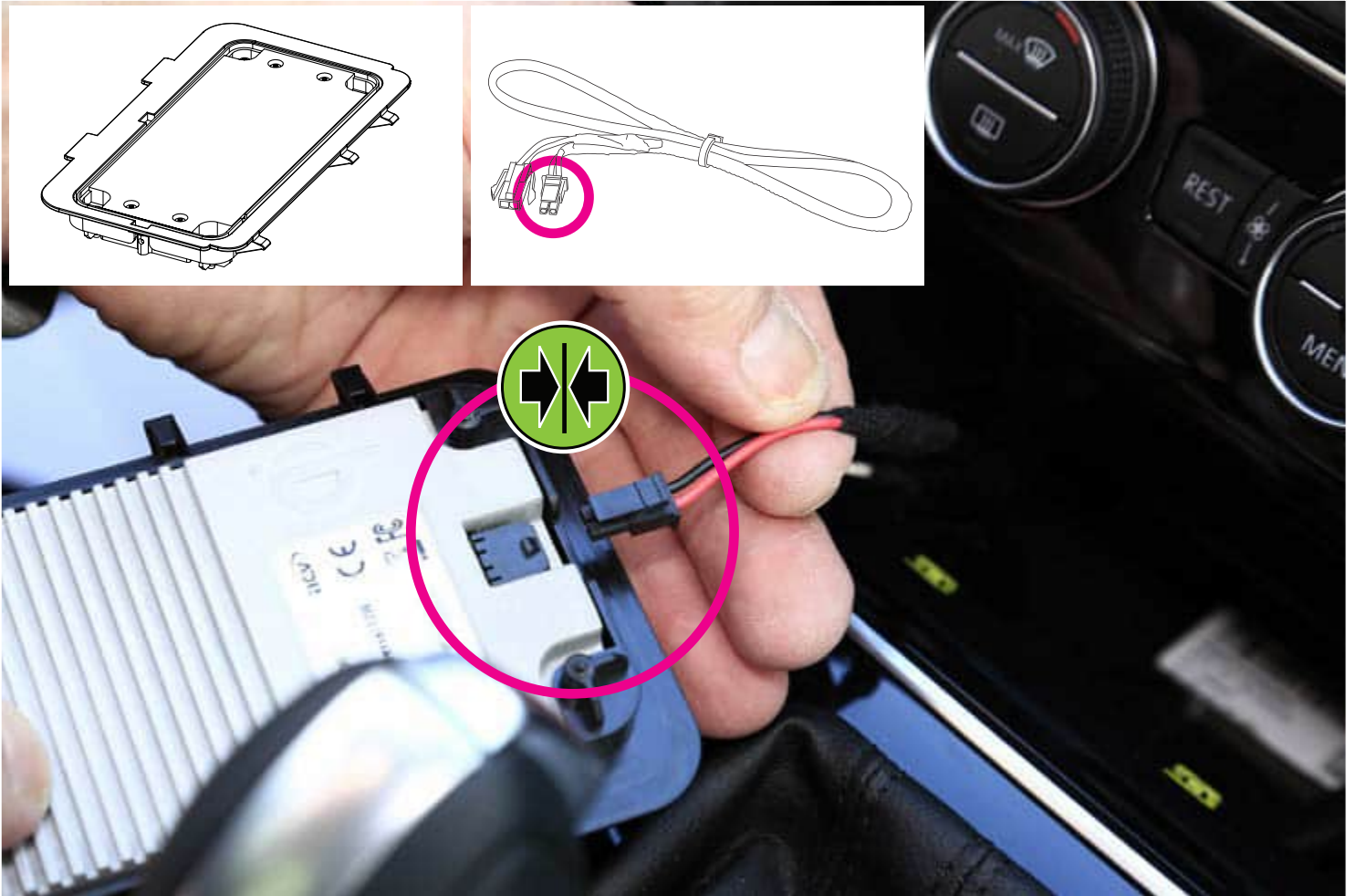



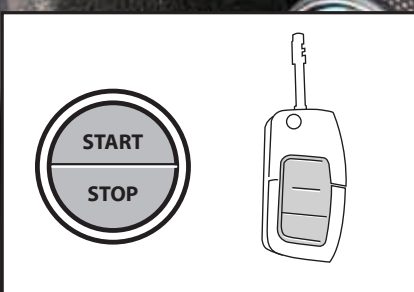

VW Golf Sportsvan









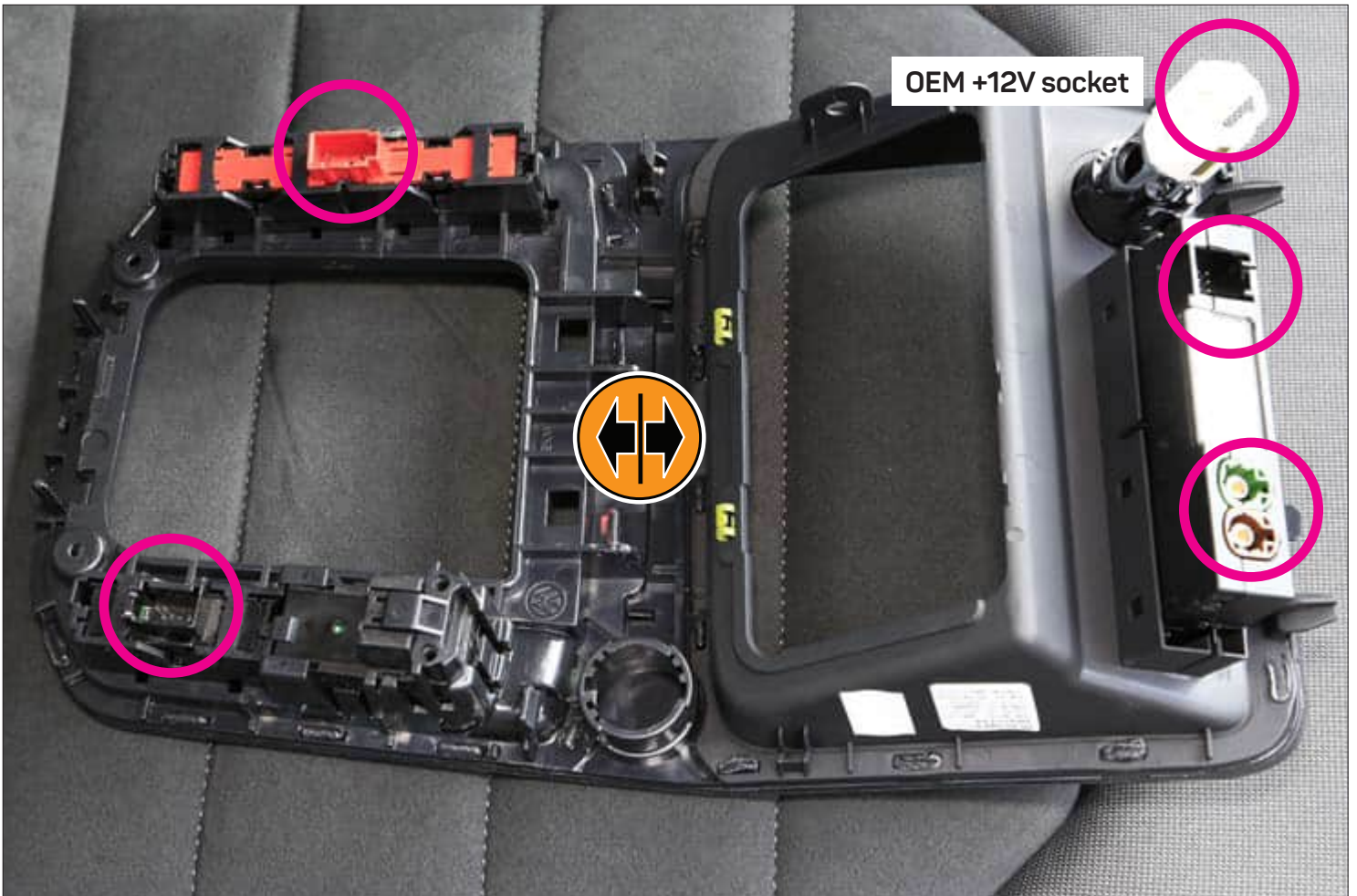

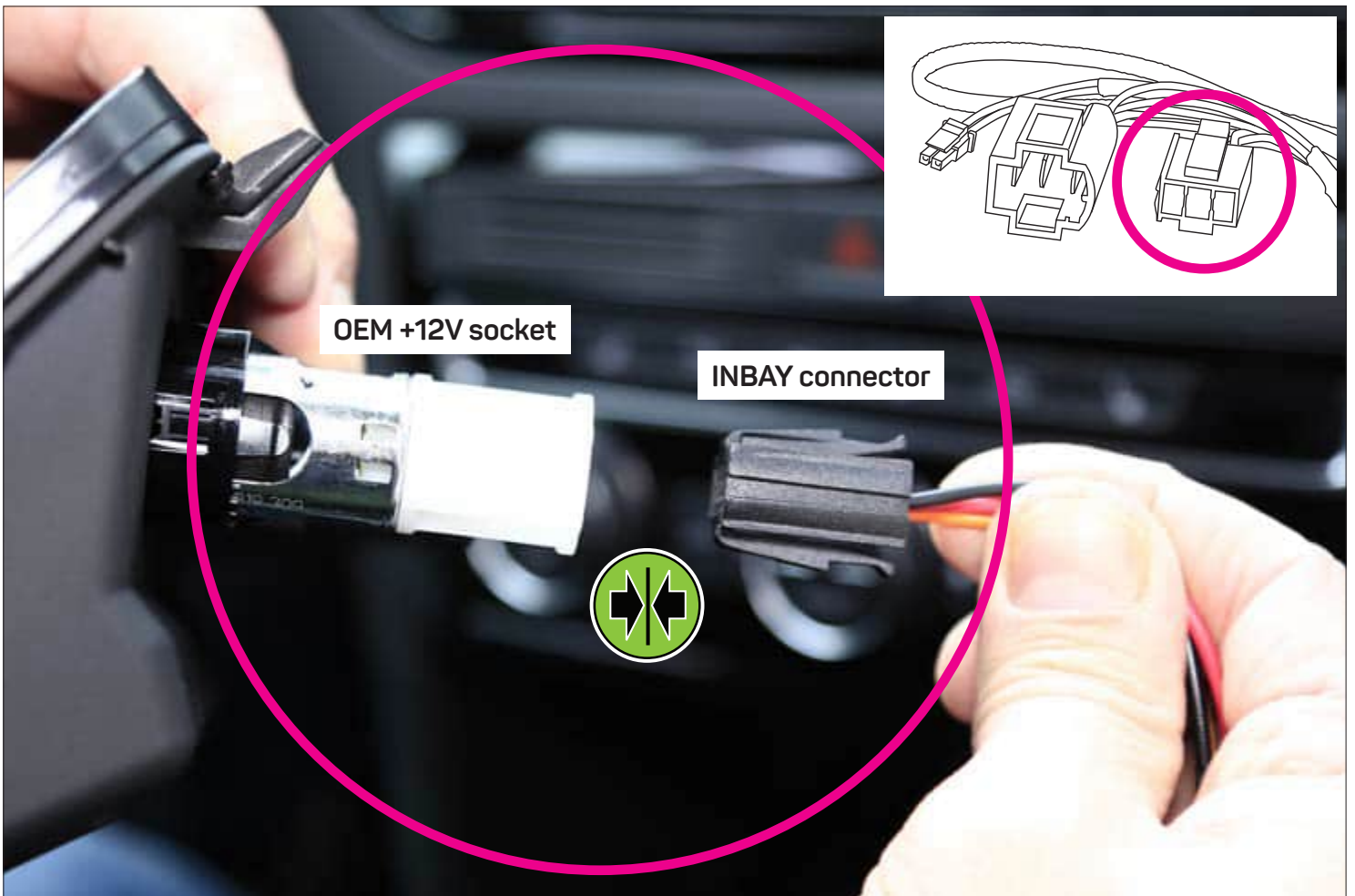
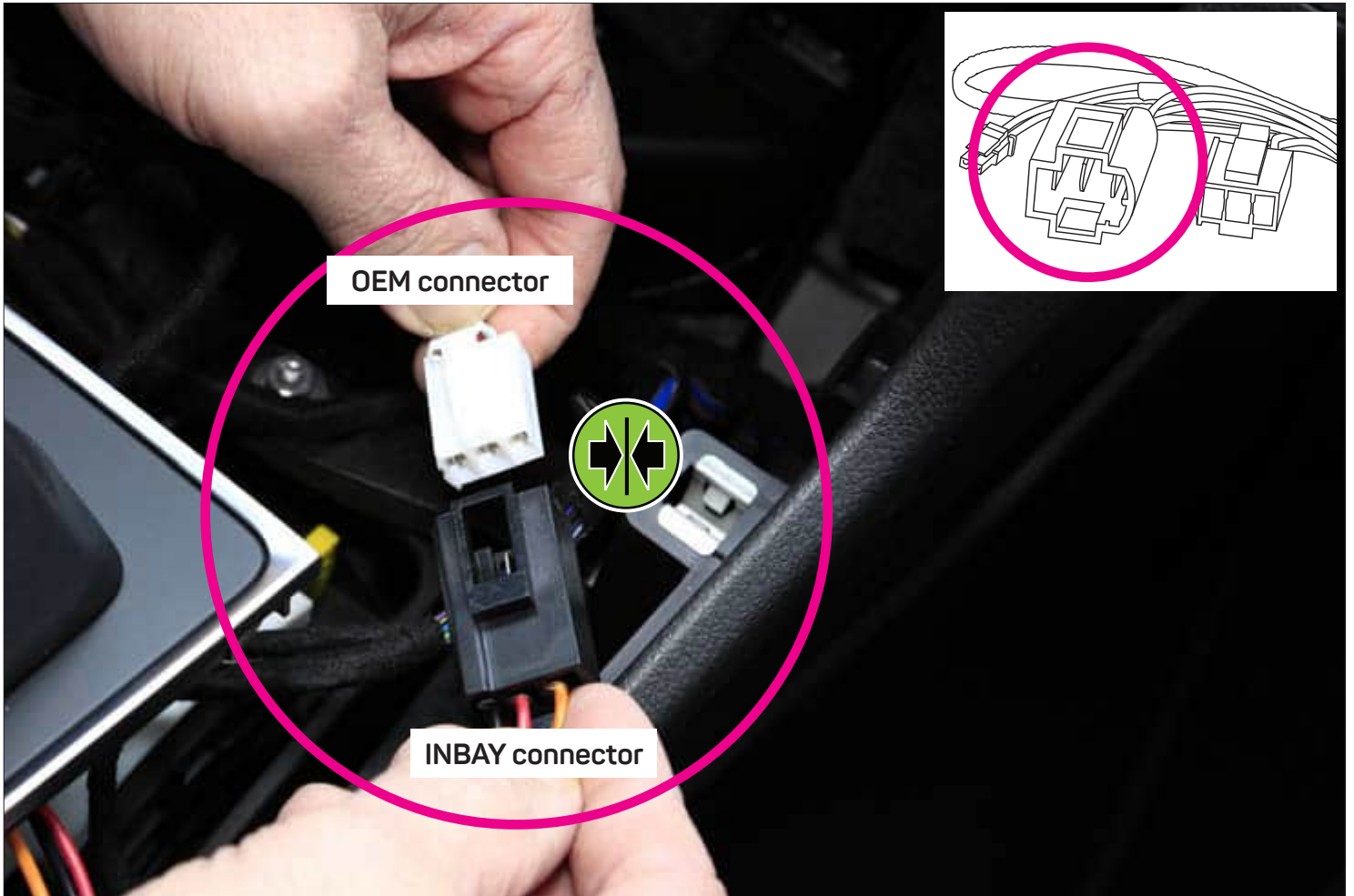

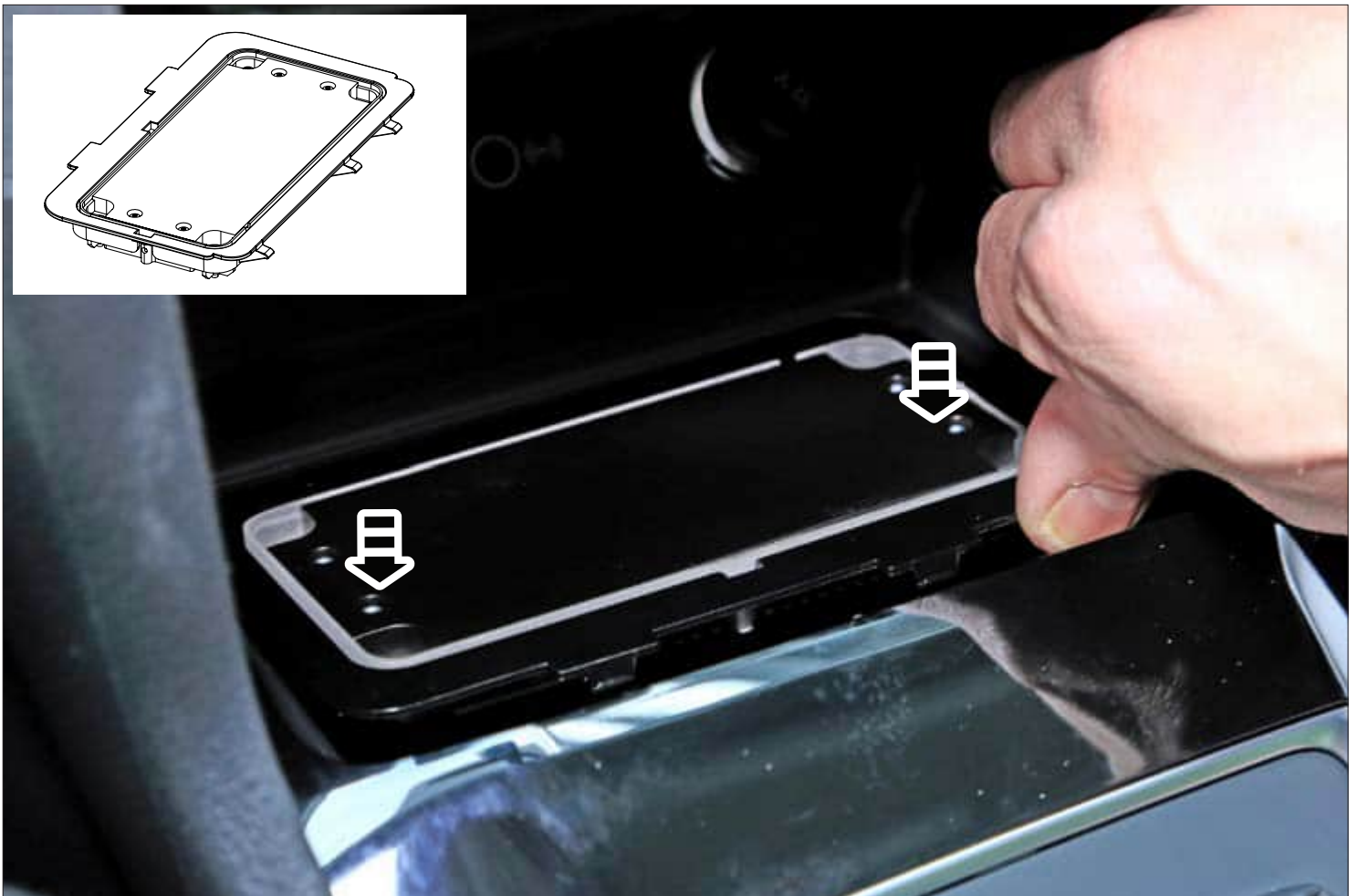
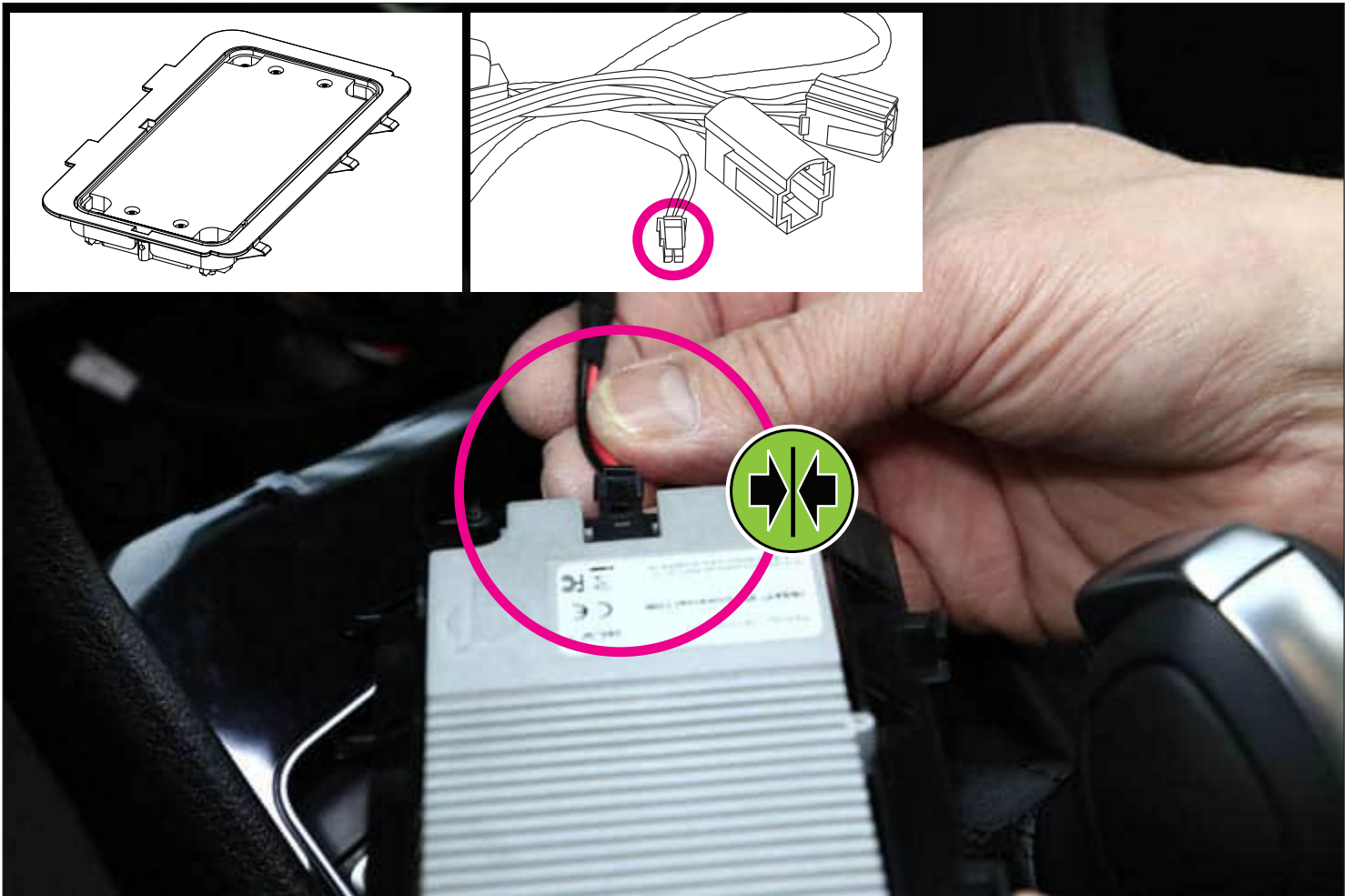



VW Polo

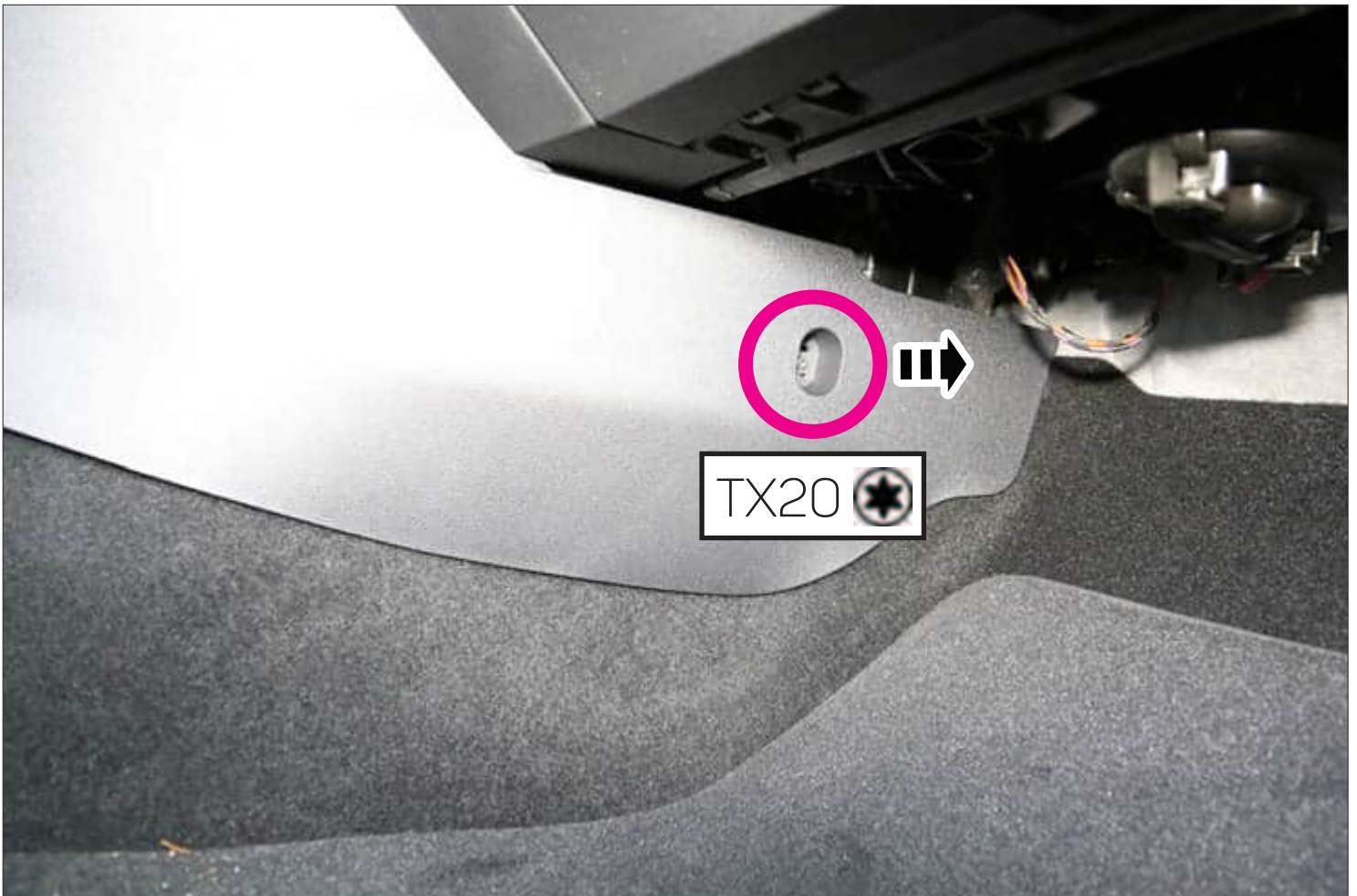





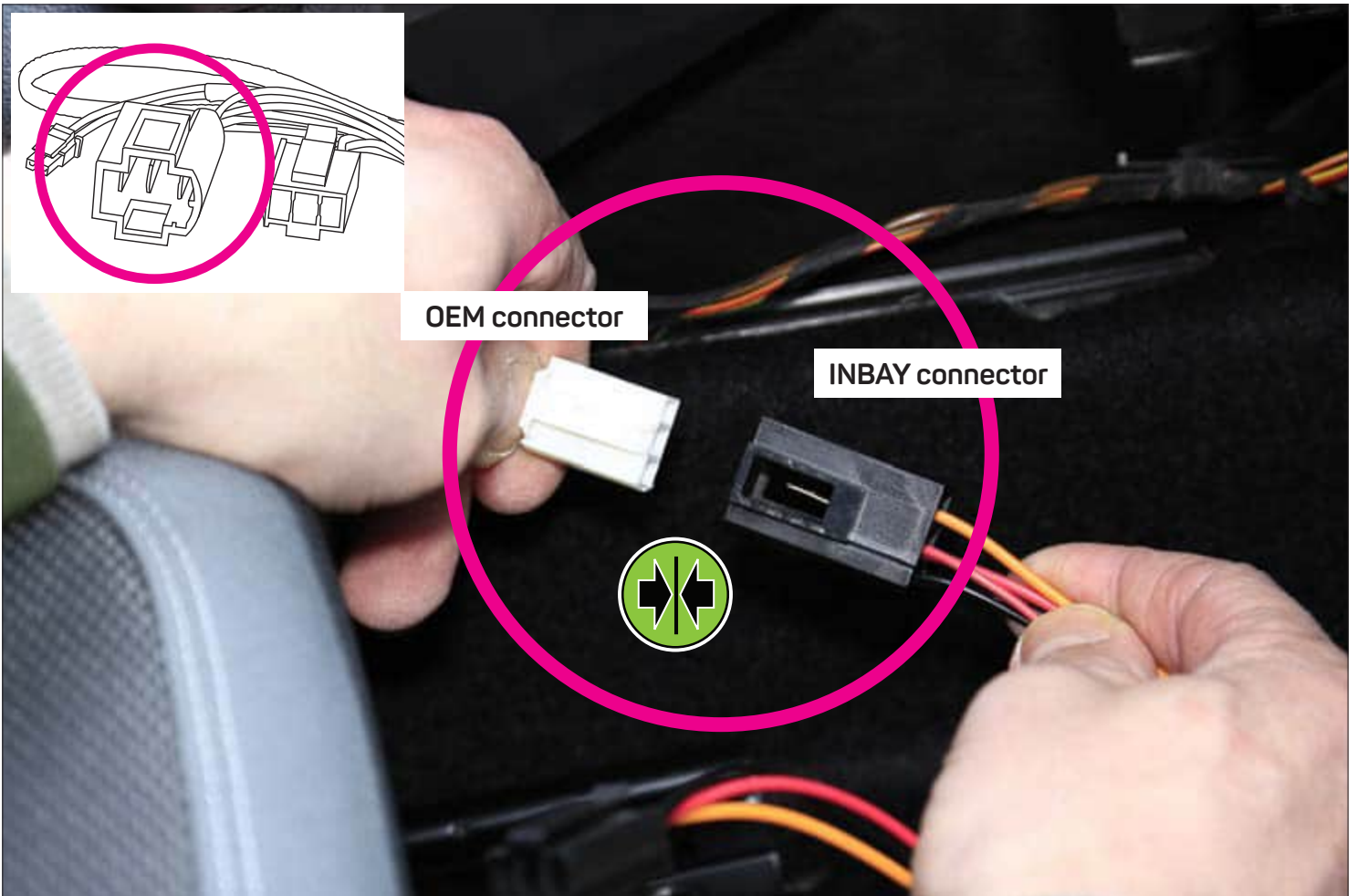
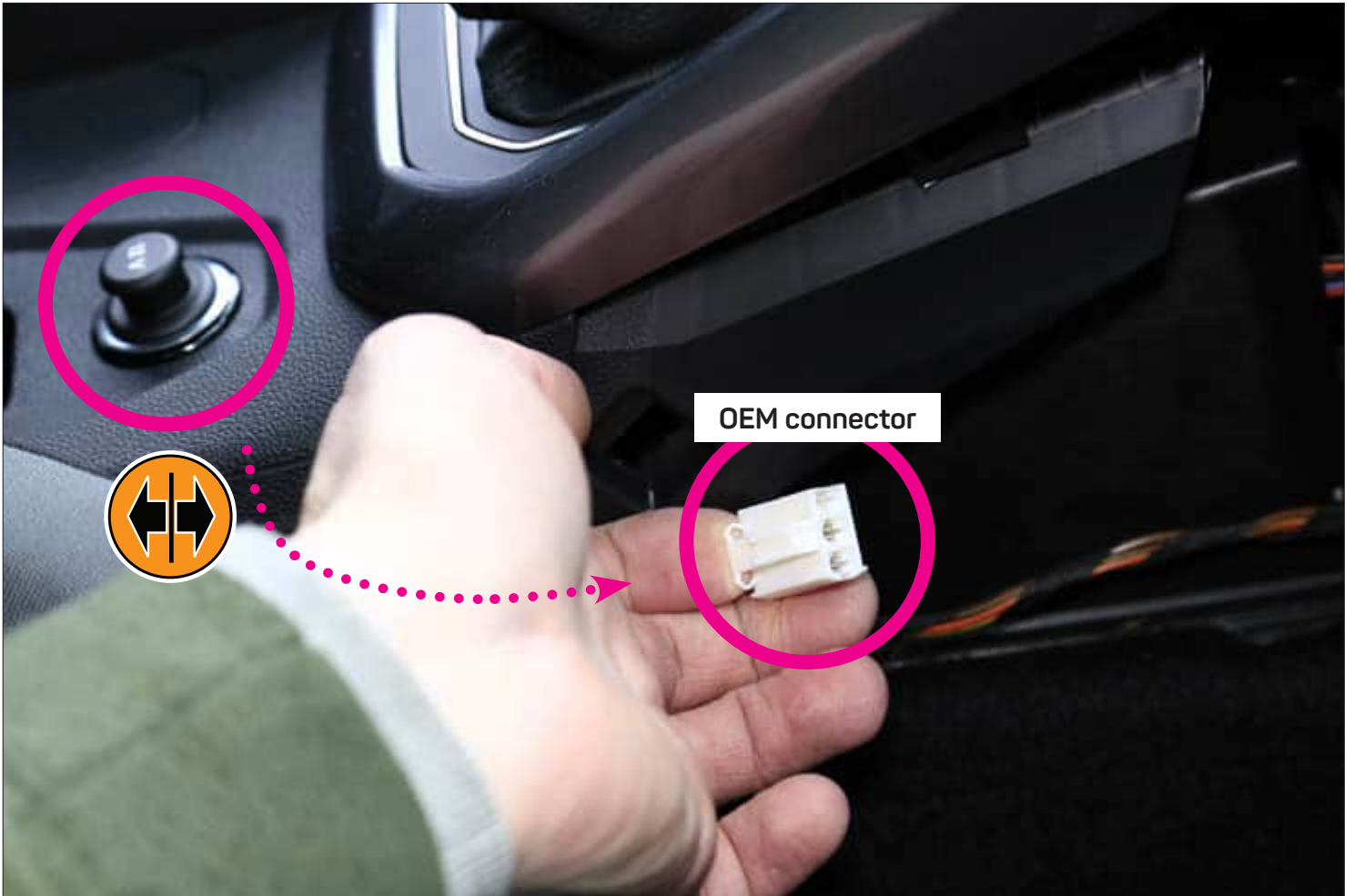

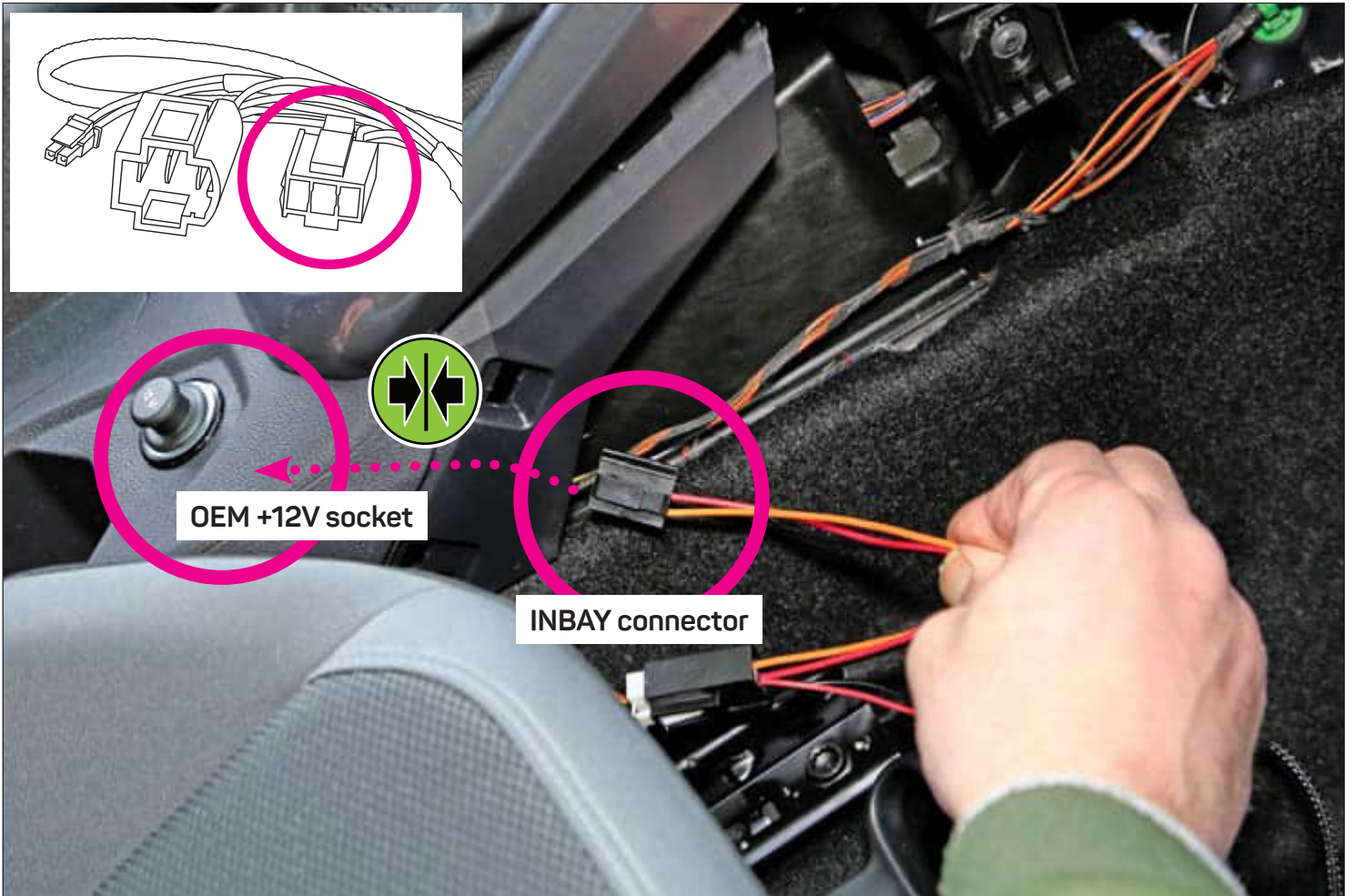

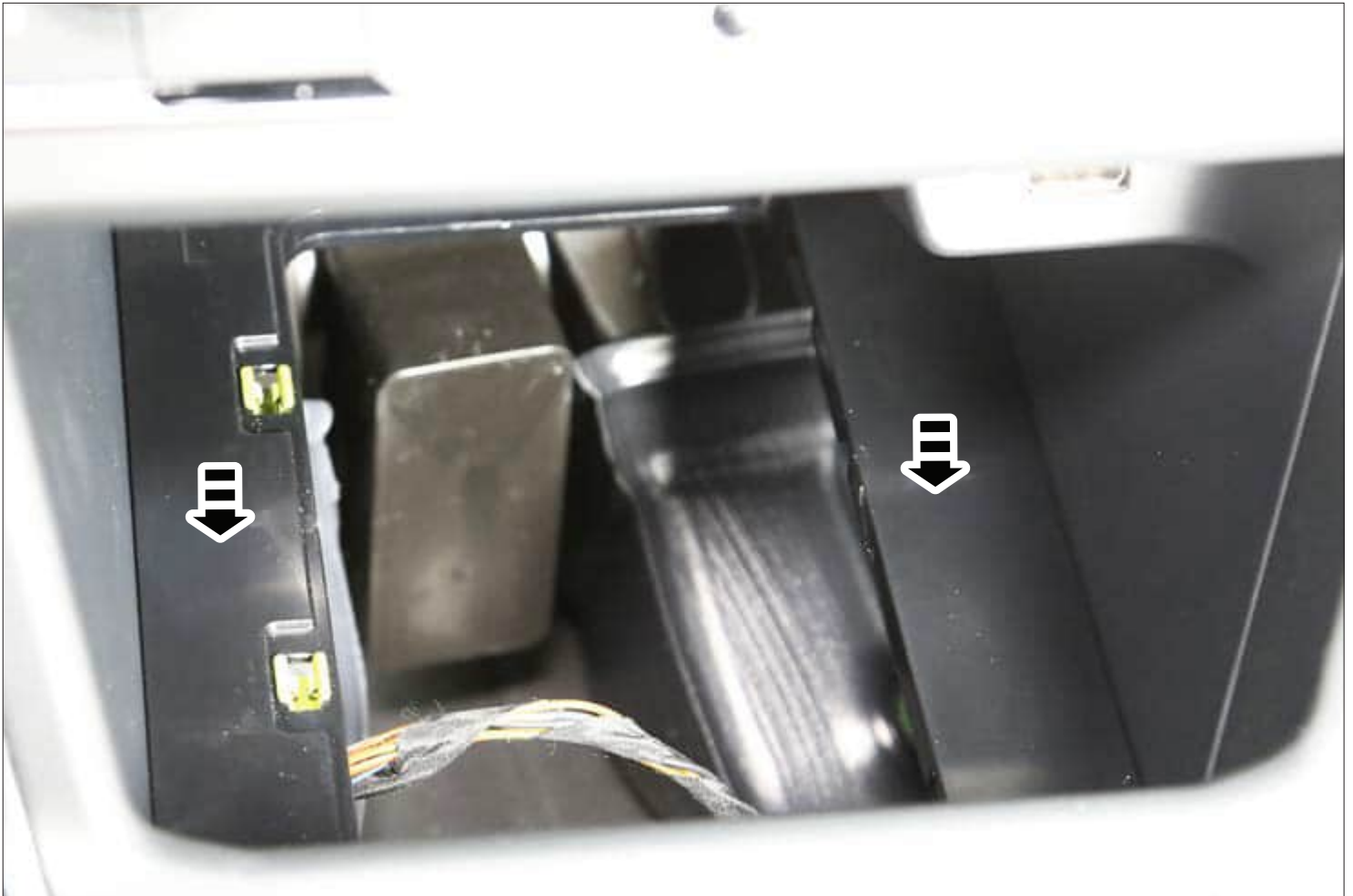

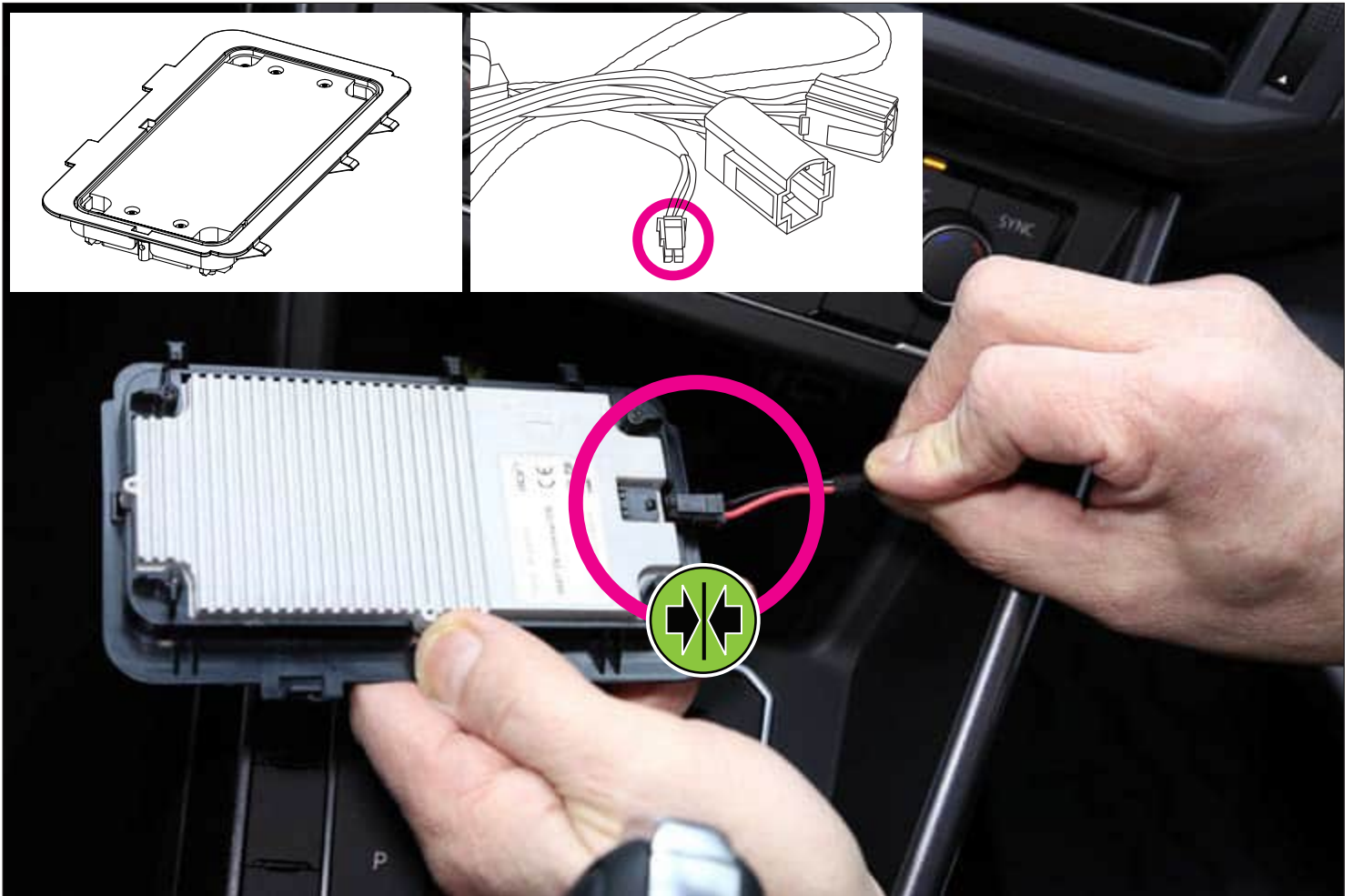



VW T-Cross





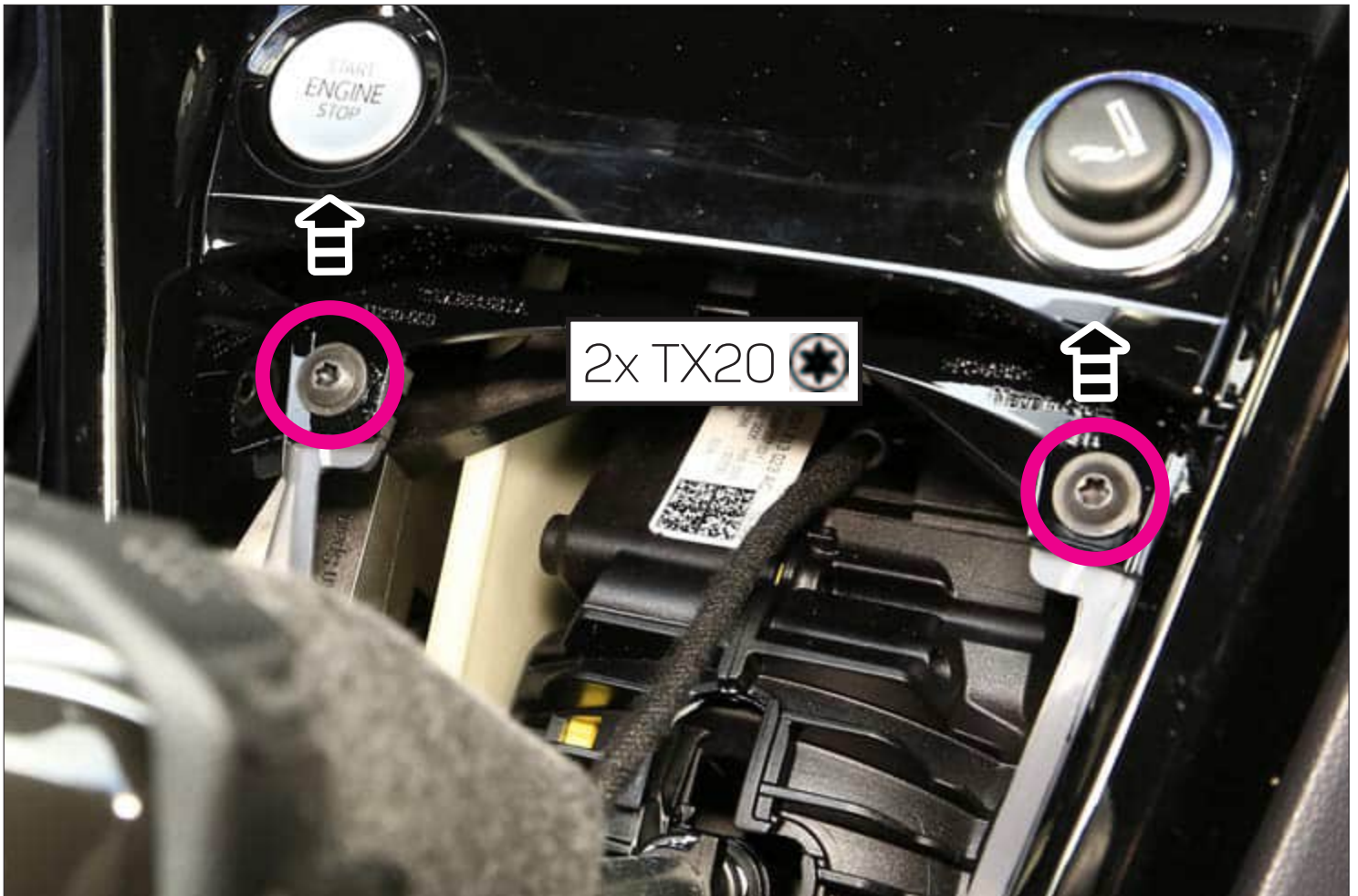



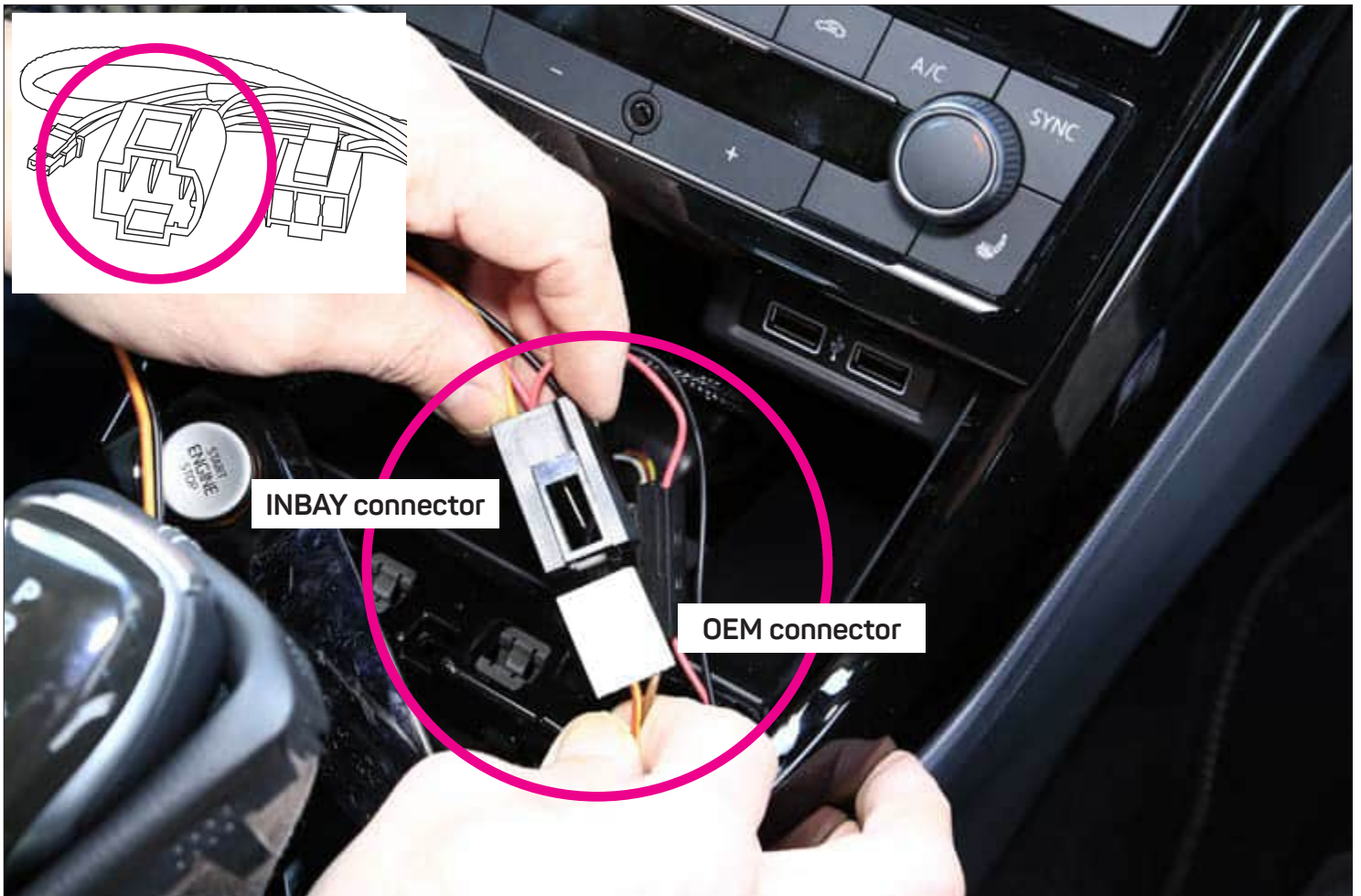
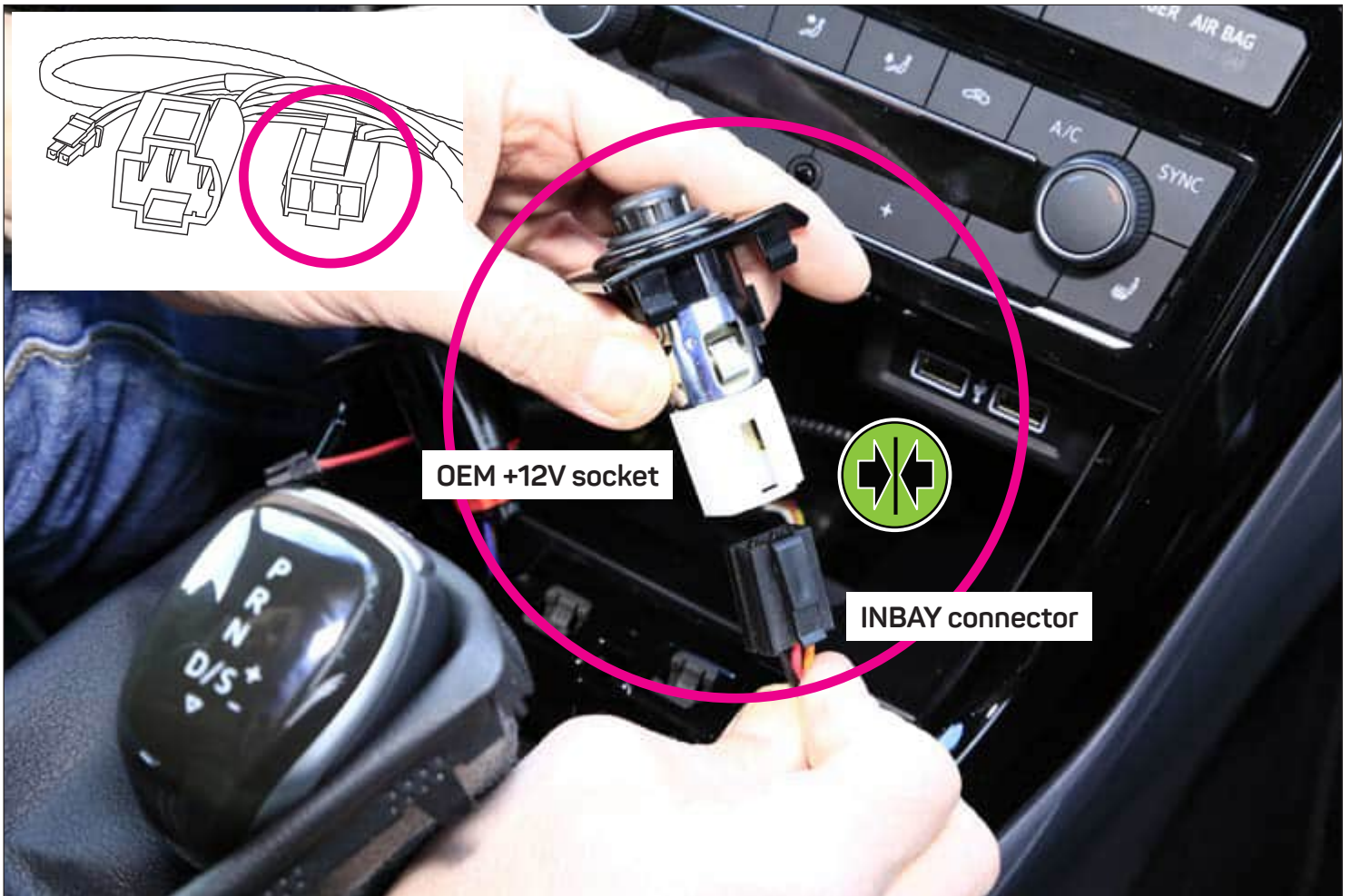

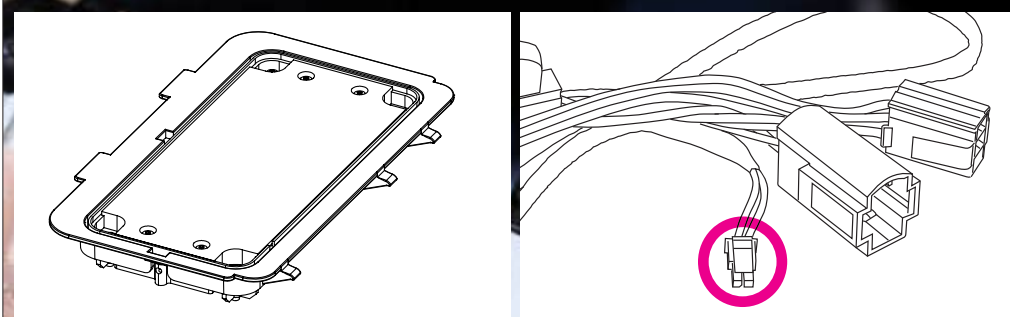





VW T-Roc / T-Roc Cabriolet

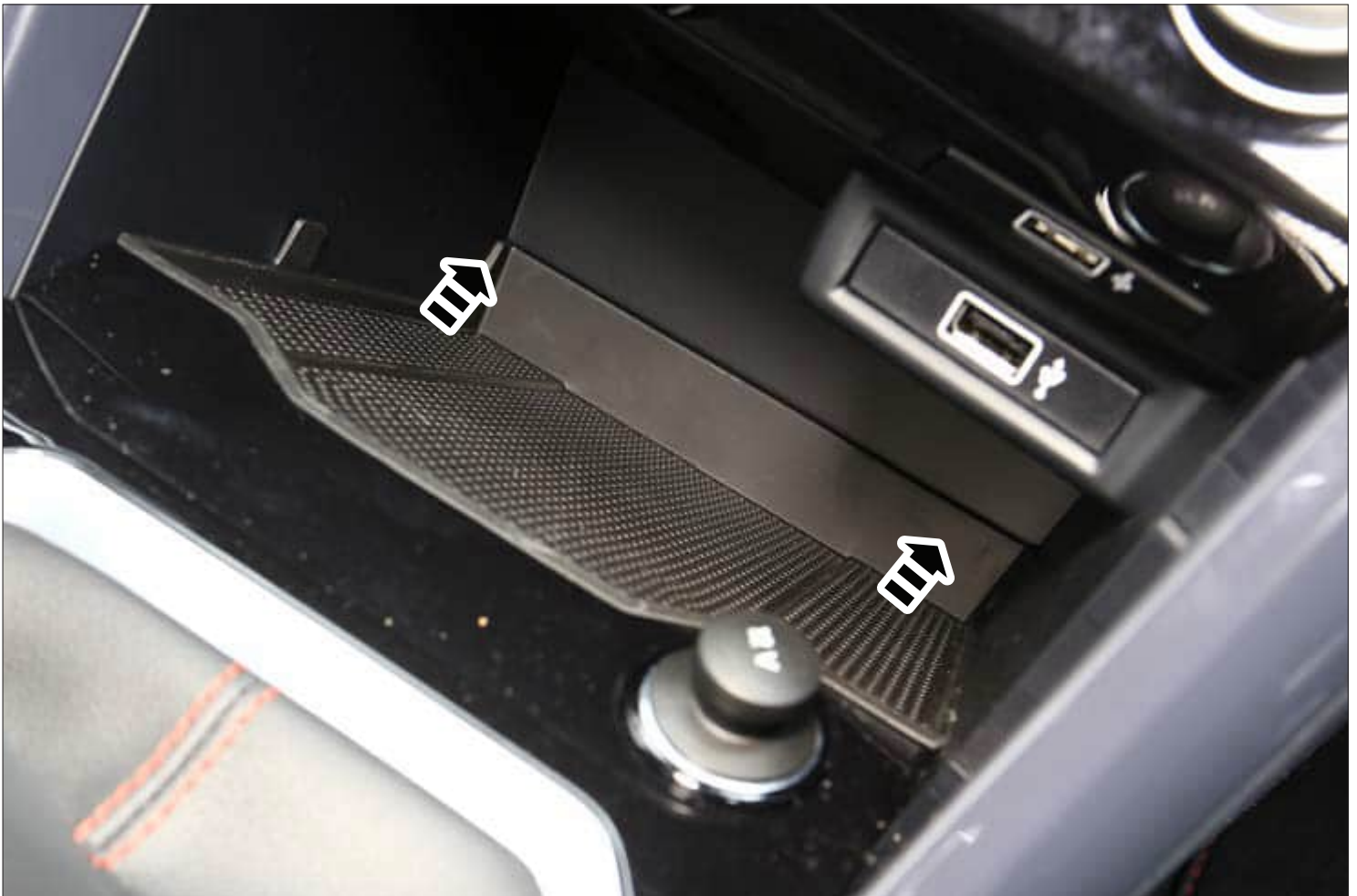



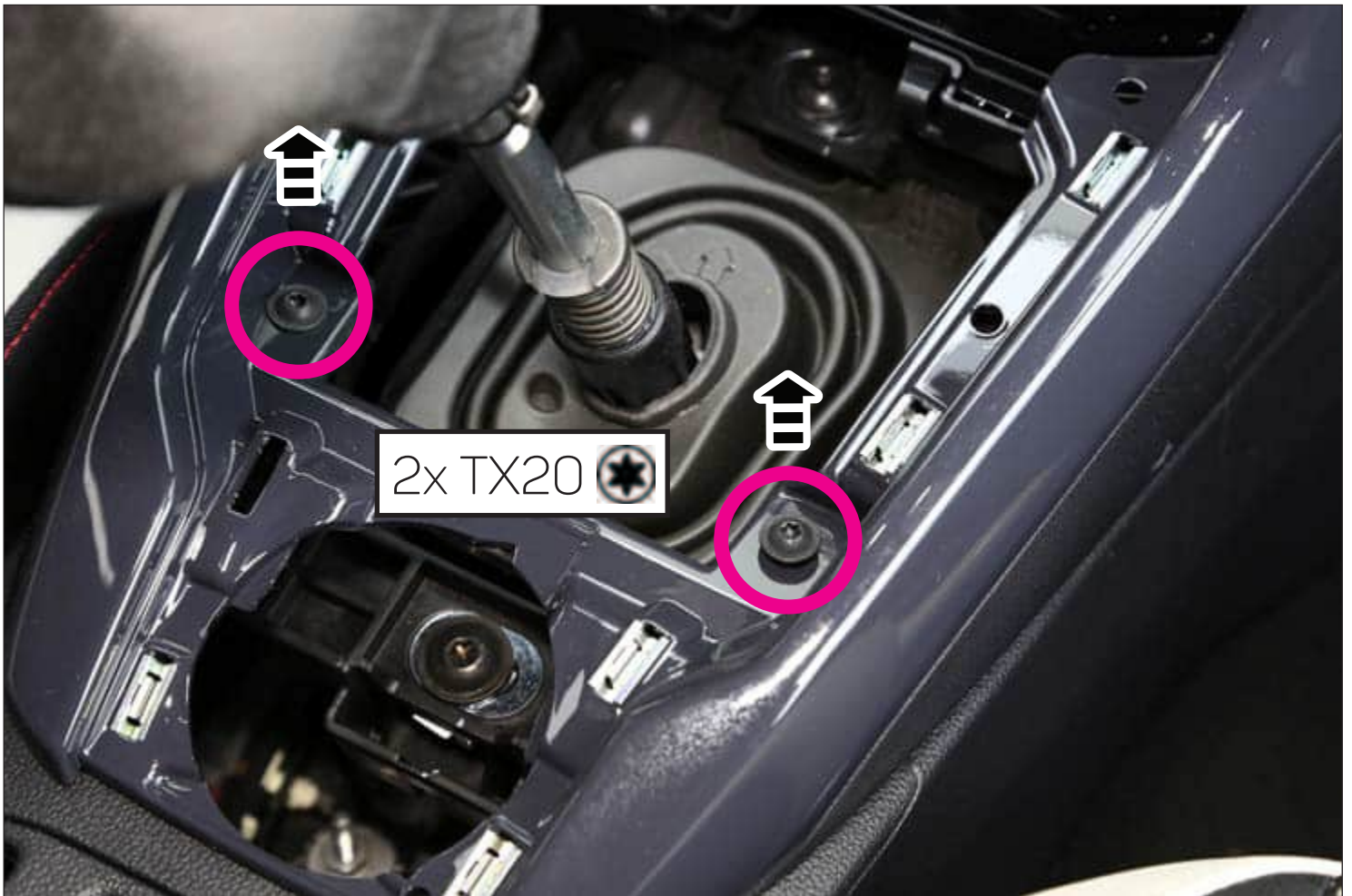

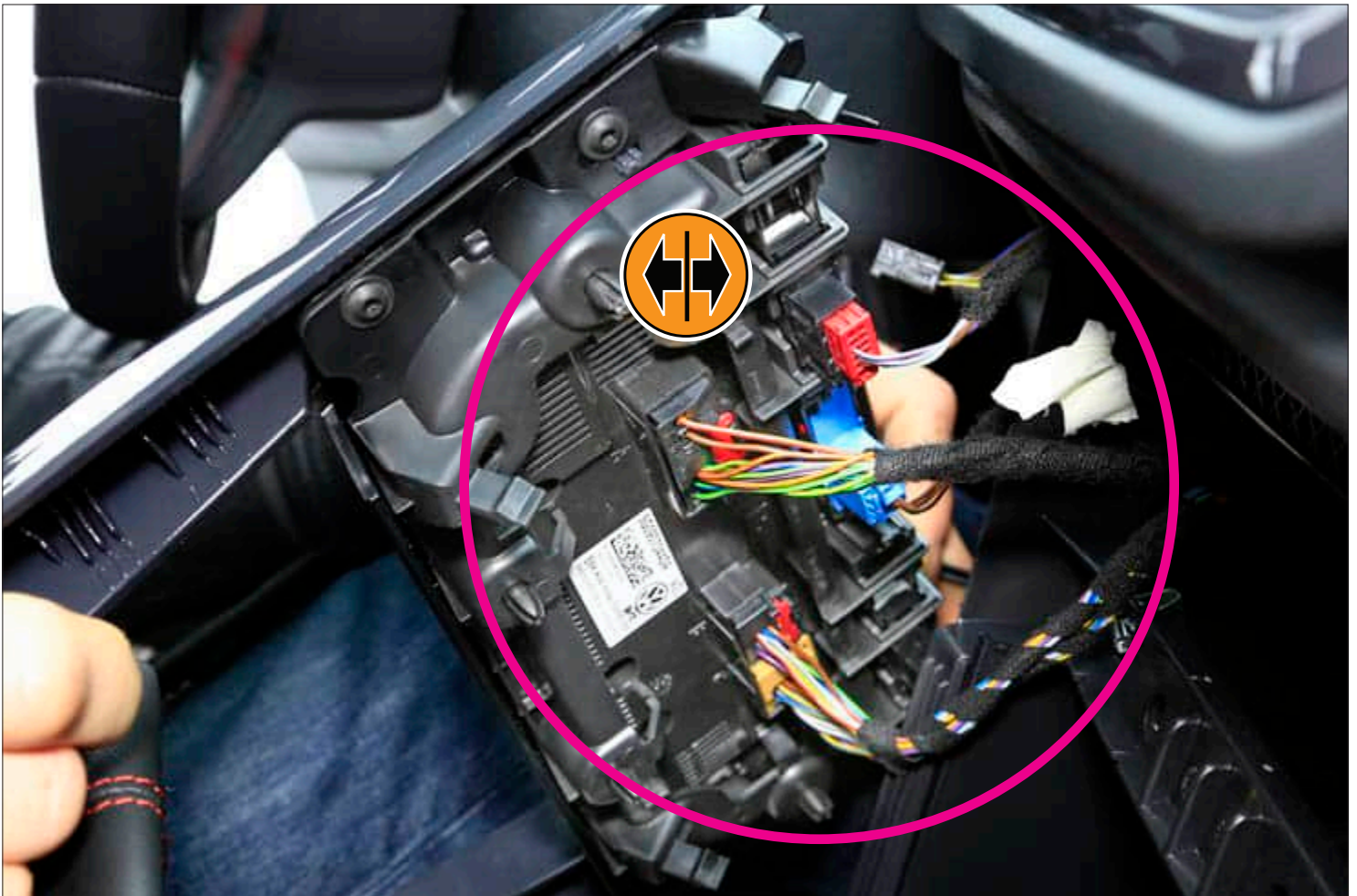

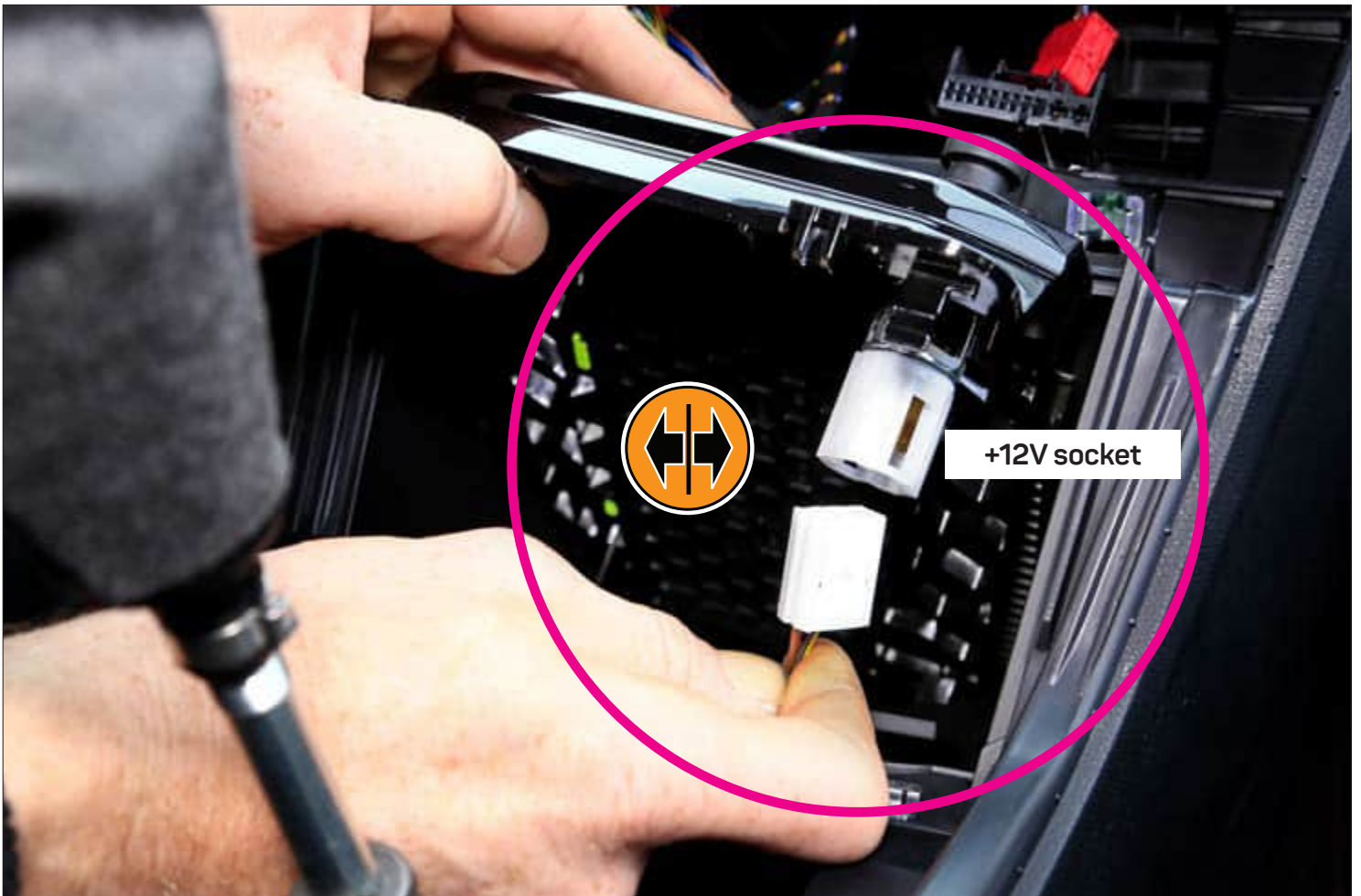

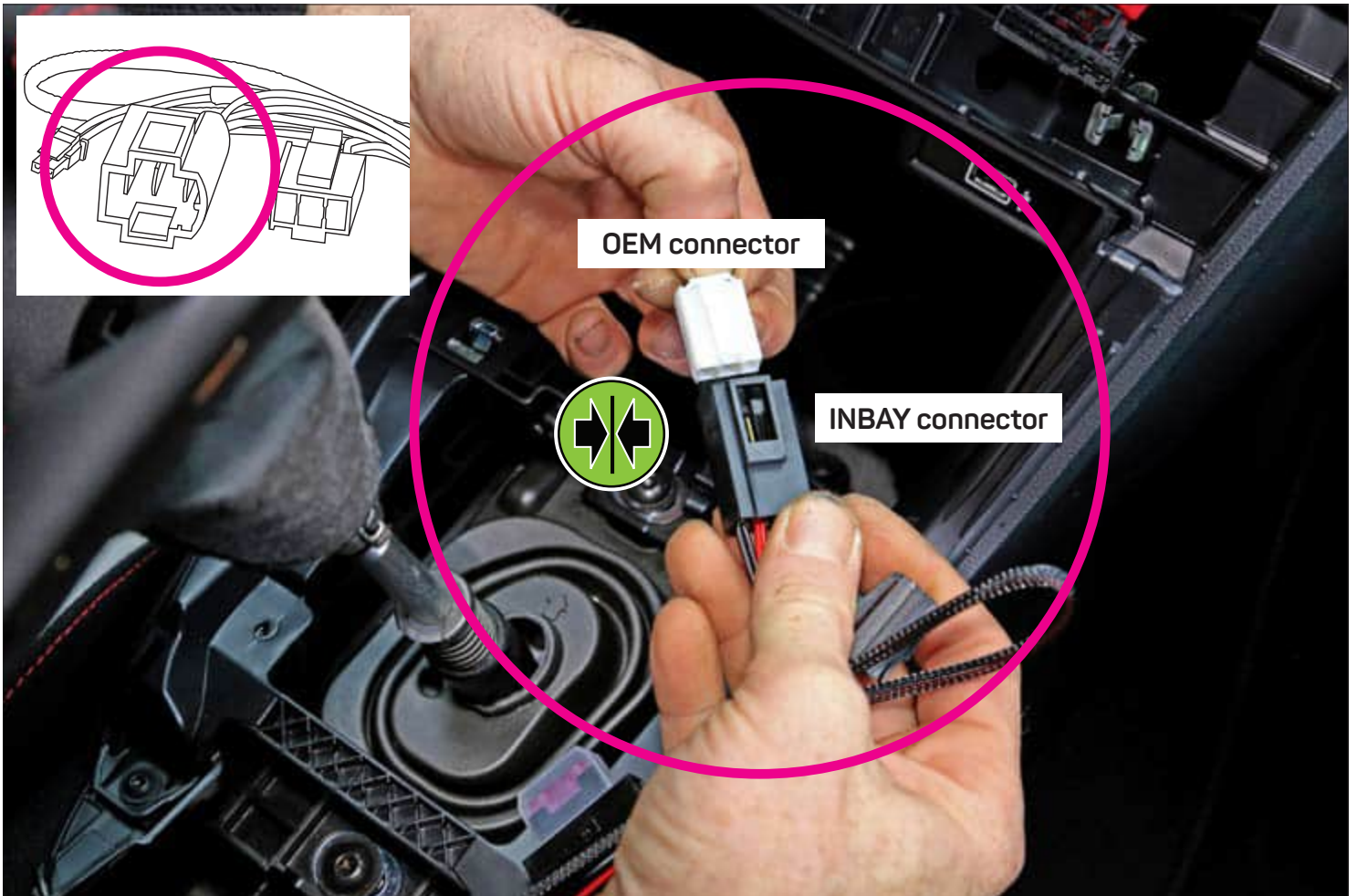
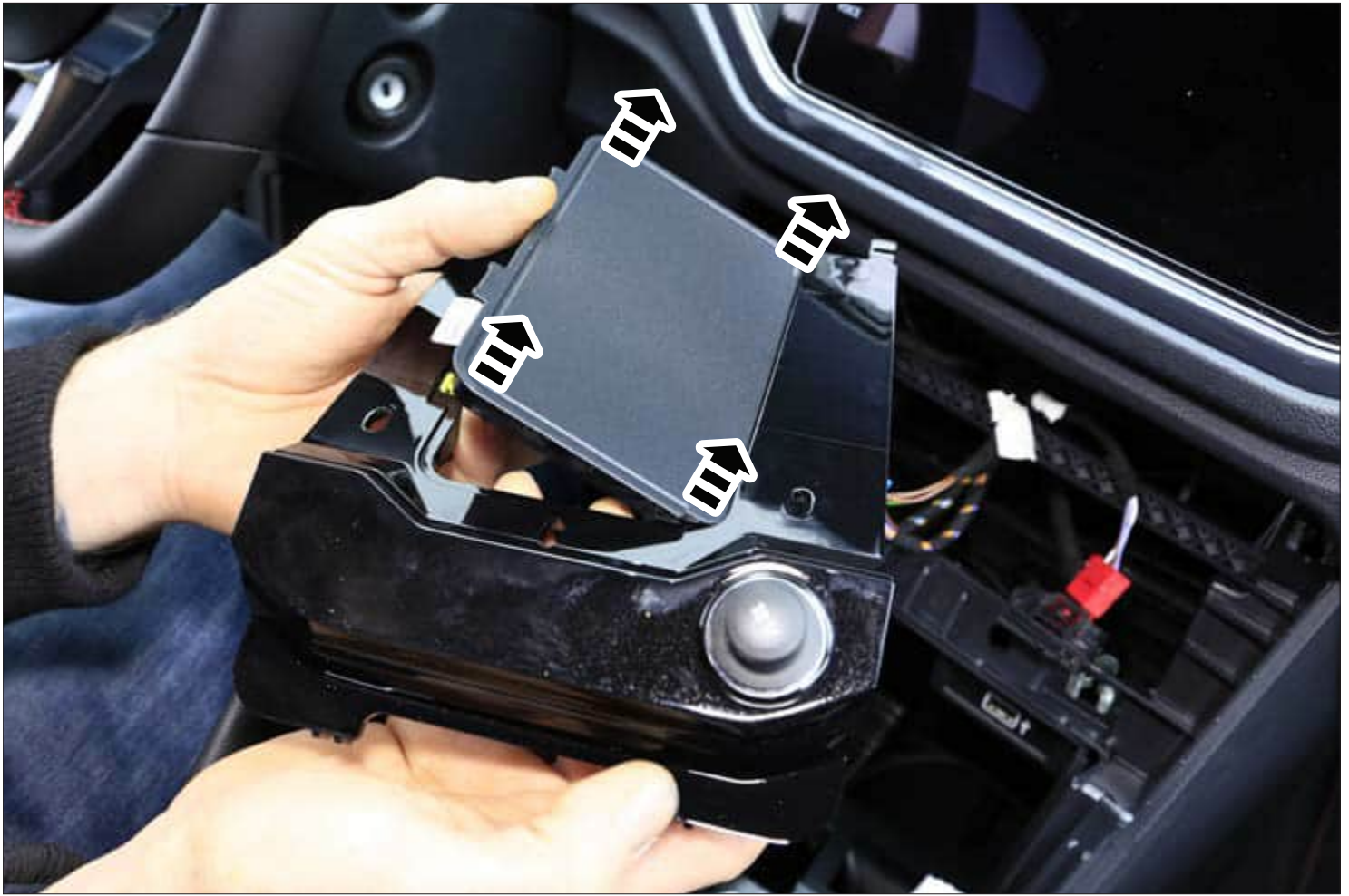

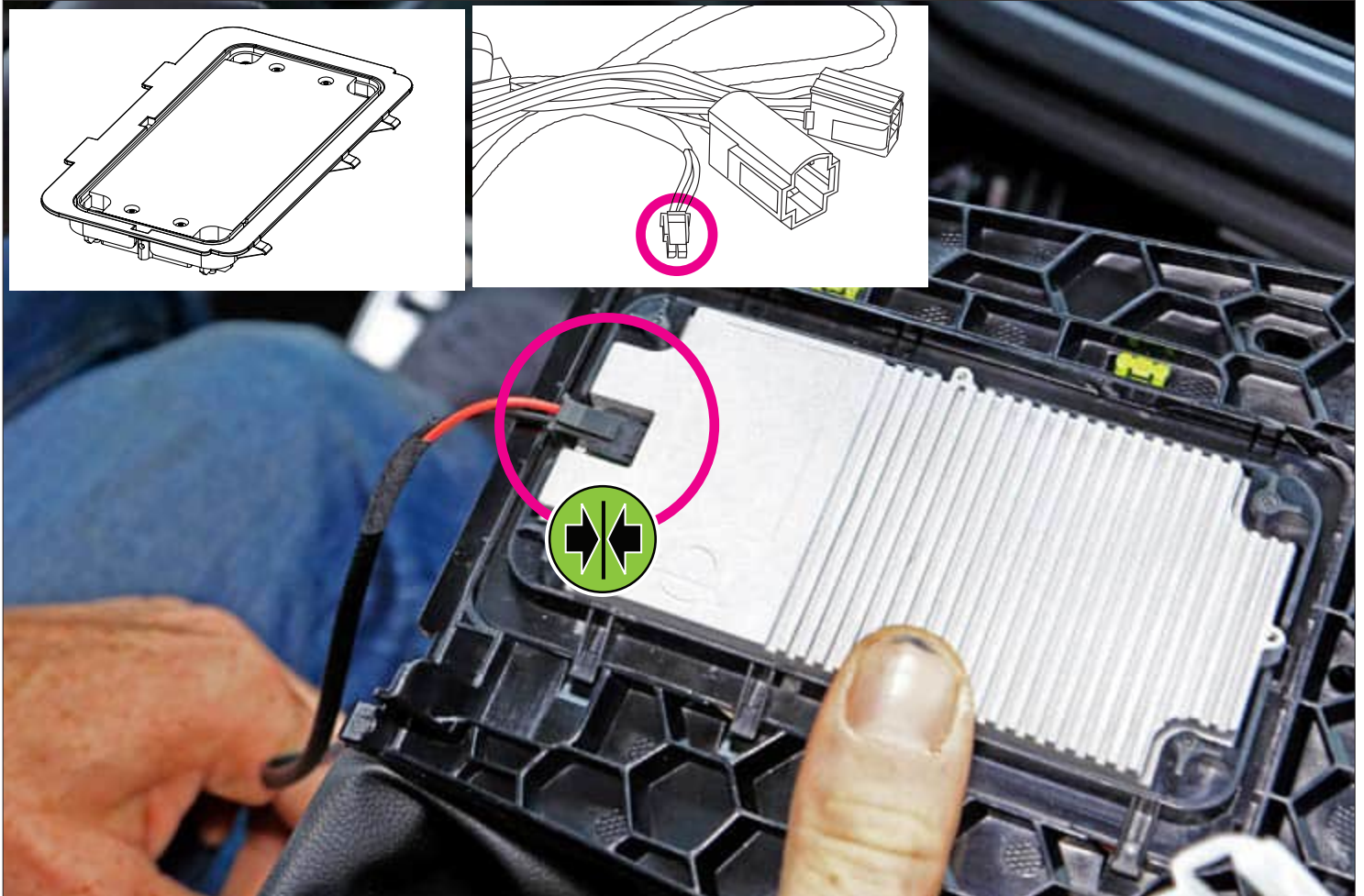

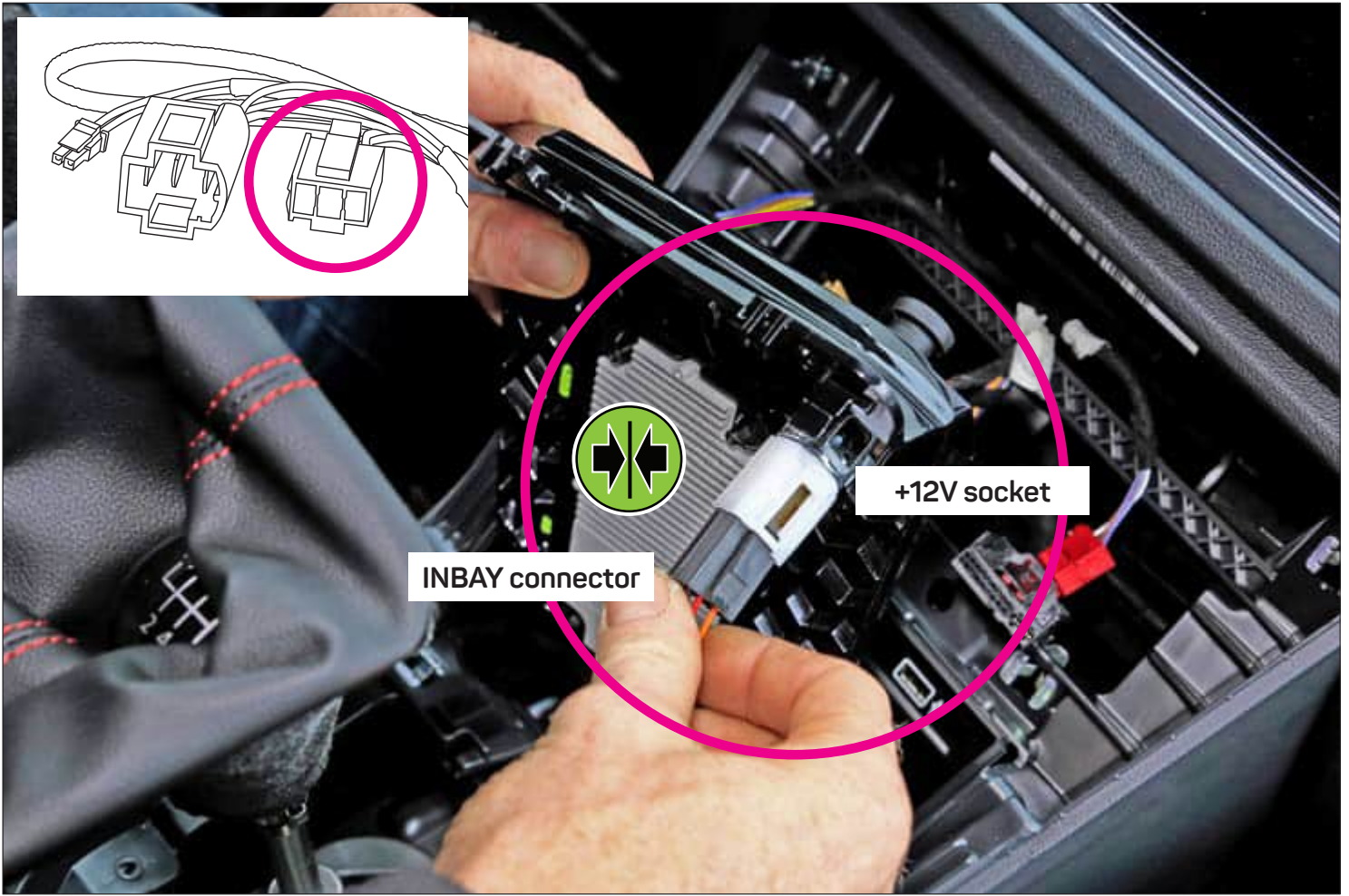



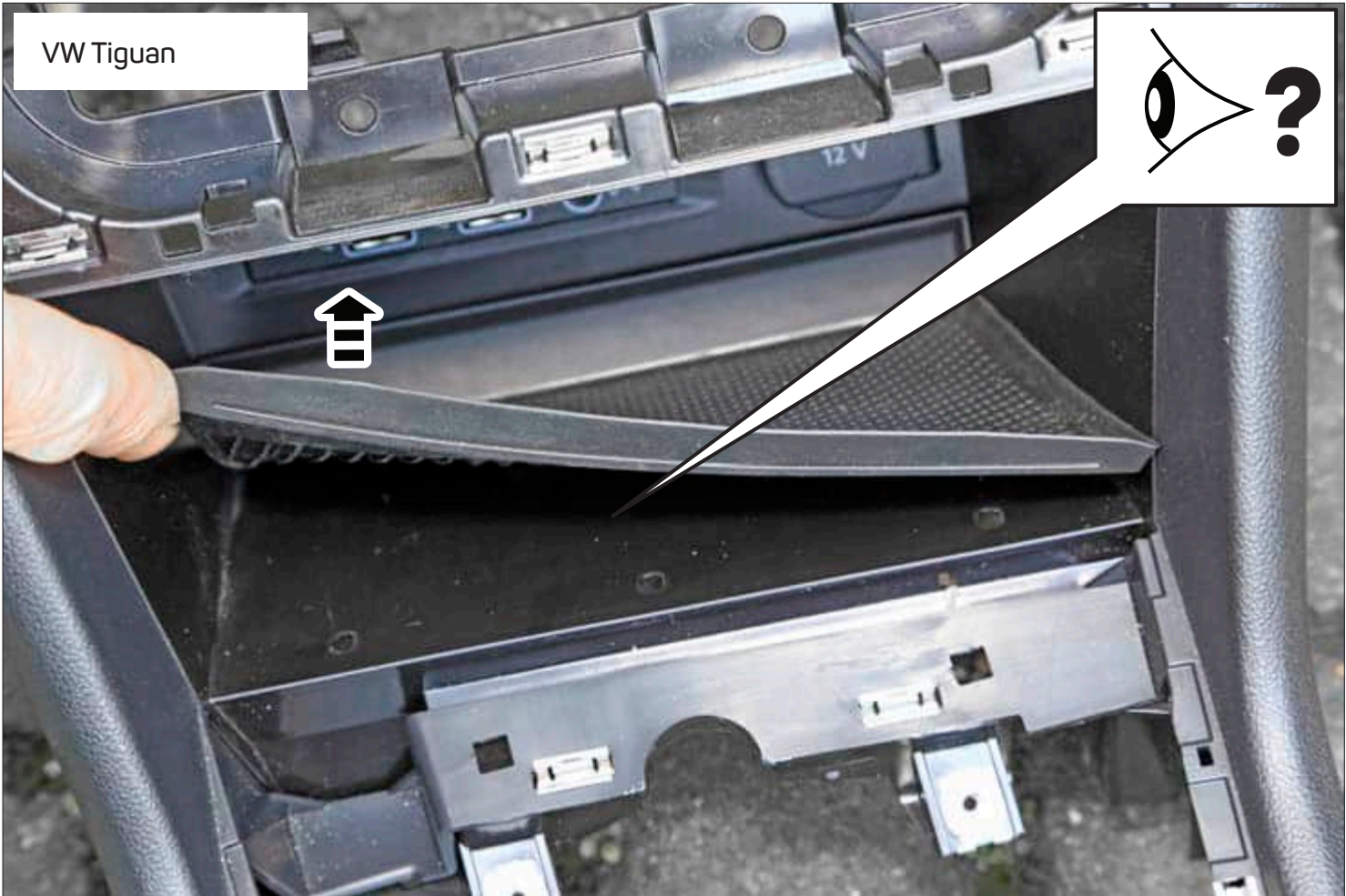

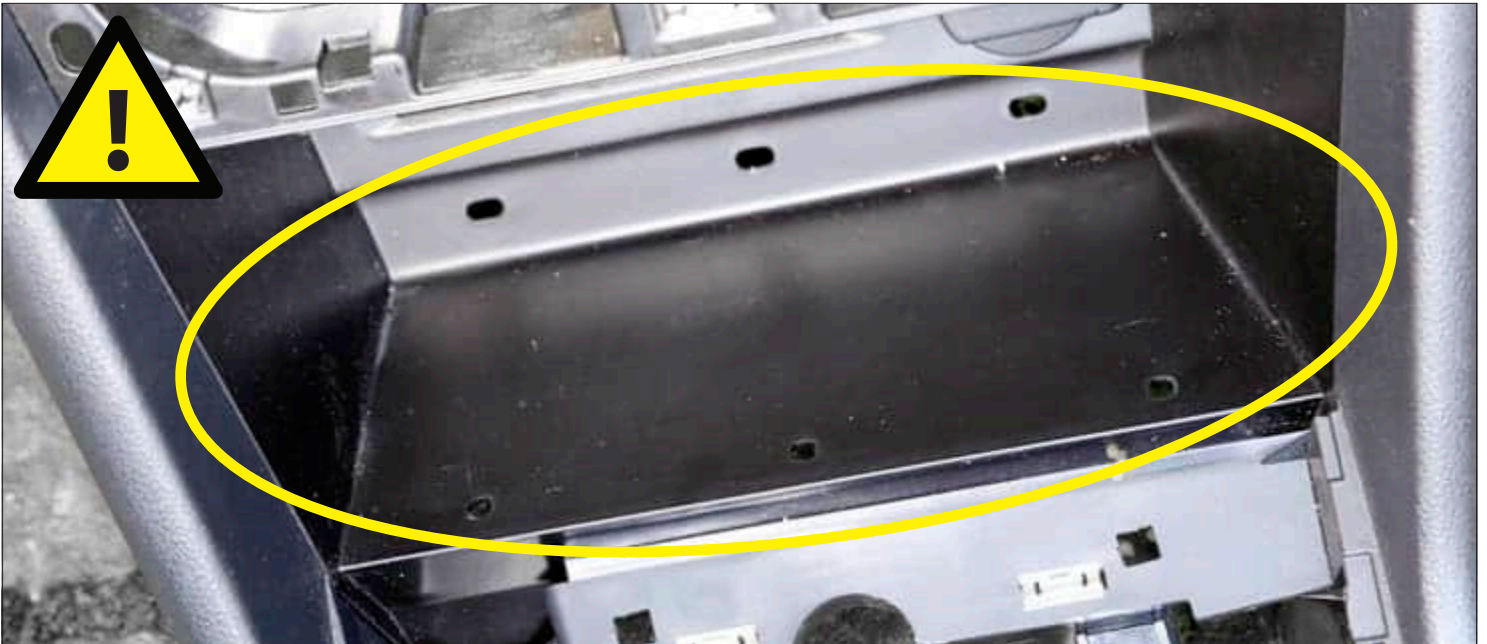

Beispiel / sample: 5NB 863 241 F 82V

Eine neue Original-Mittelkonsole (VW-Teile Nr.: 5NB 863 241 F ***) mit Aussparung für das Subsystem wird benötigt. Bitte überprüfen Sie vor Bestellung die Farbe Ihrer Innenausstattung anhand der Fahrgestellnummer.

A new original panel (VW part no.: 5NB 863 241 F ***) with opening for the subsystem is required. Please check the colour on basis of the VIN (vehicle identification number) before ordering.



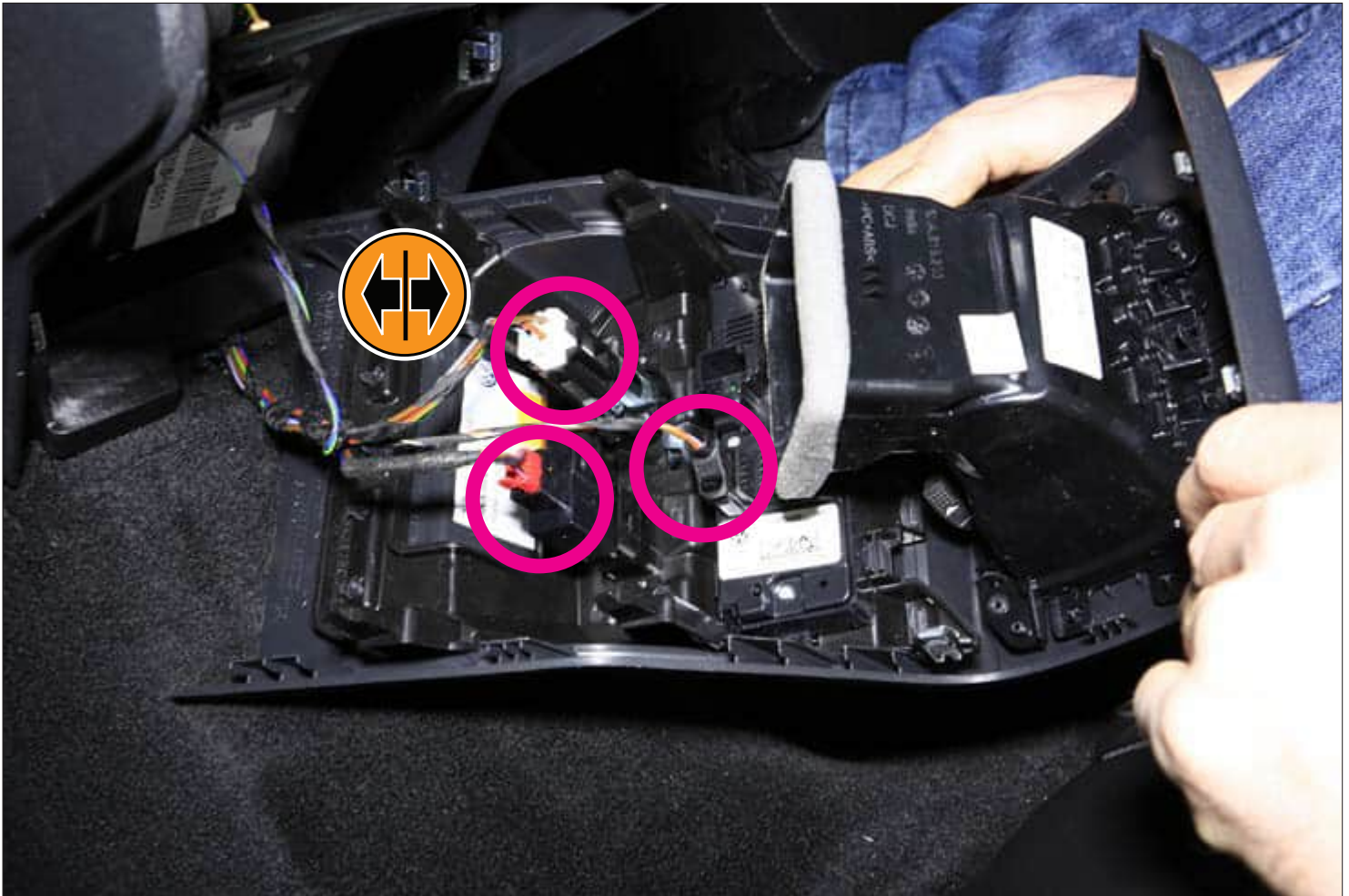

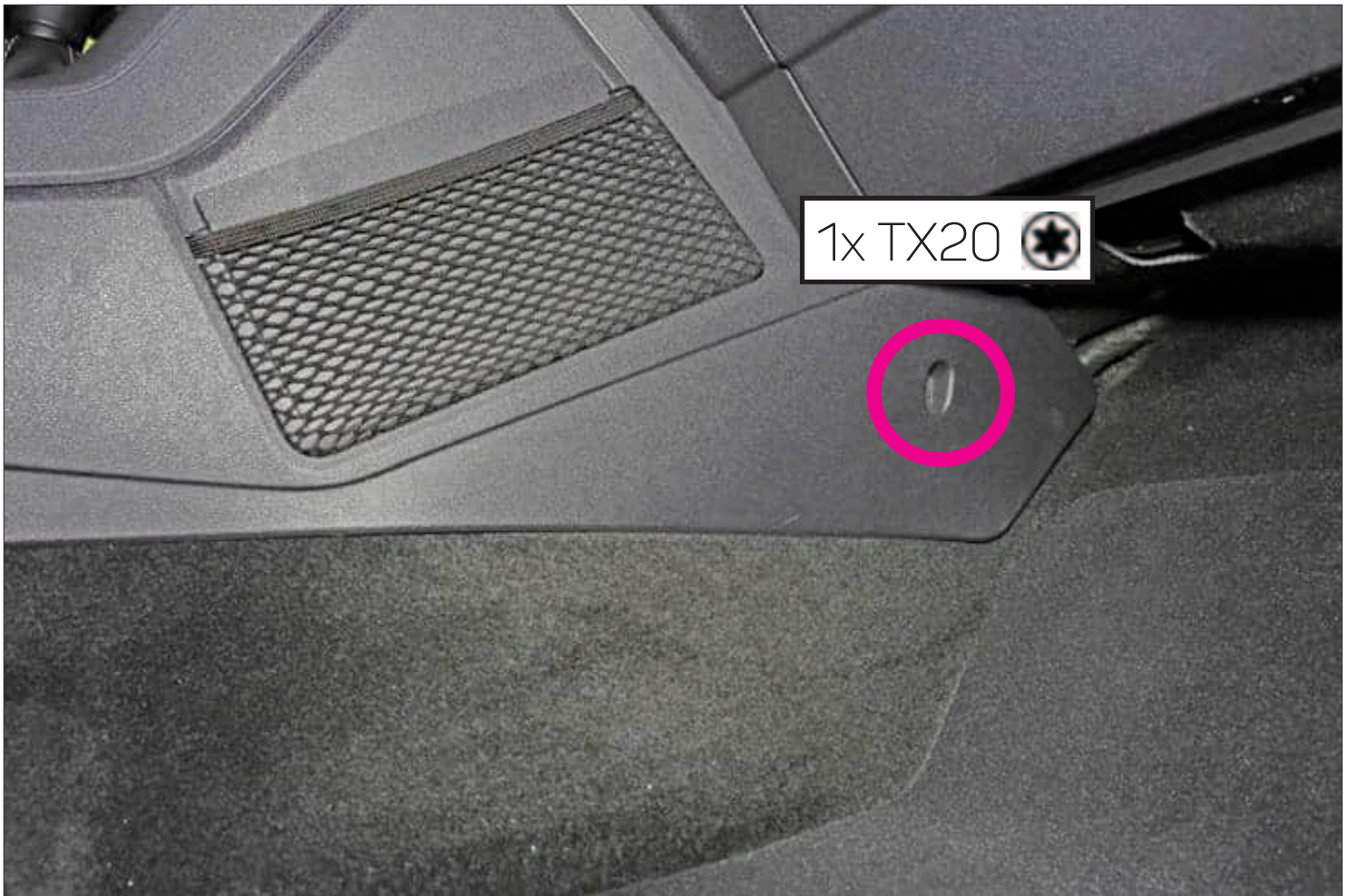



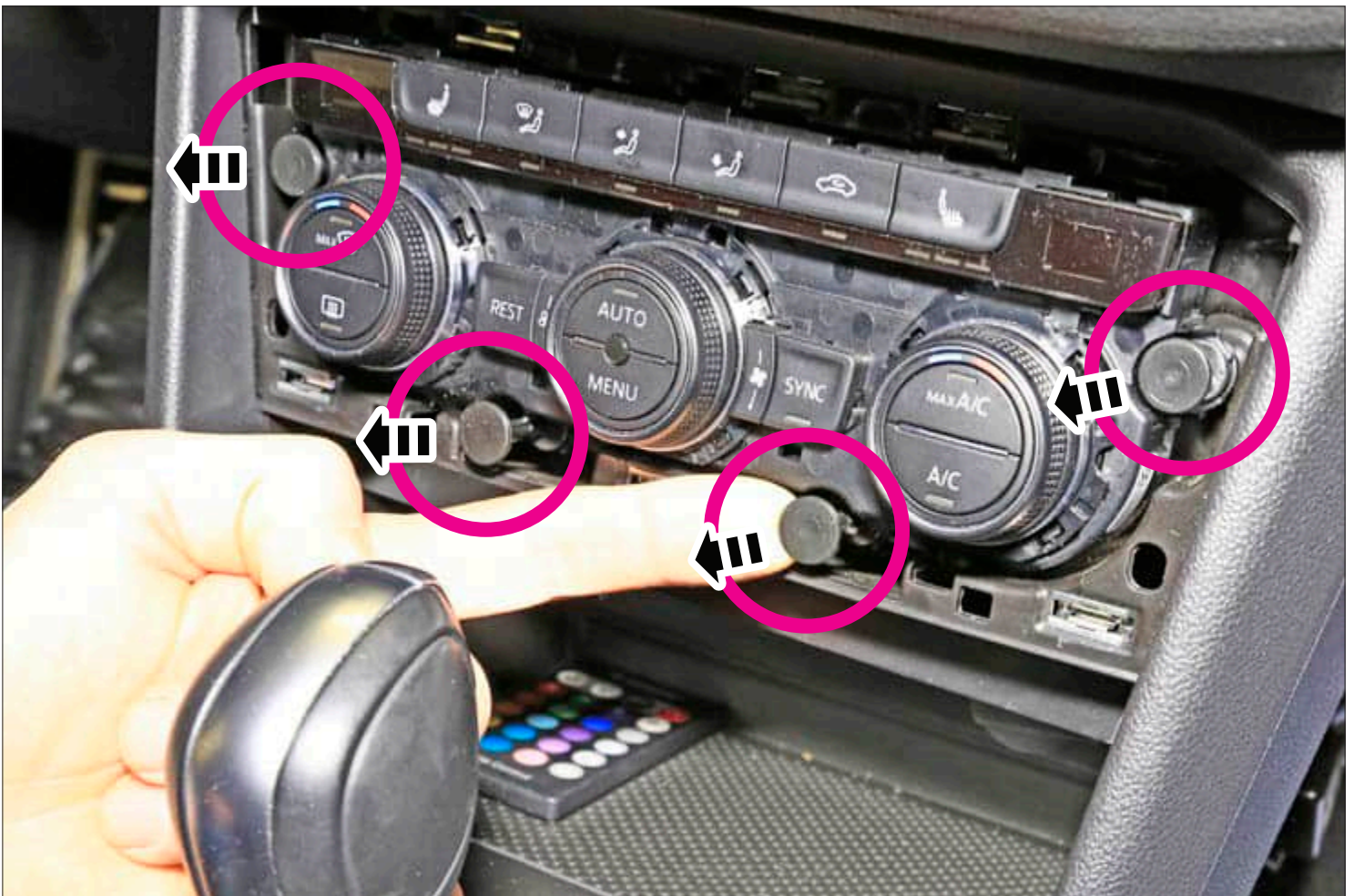

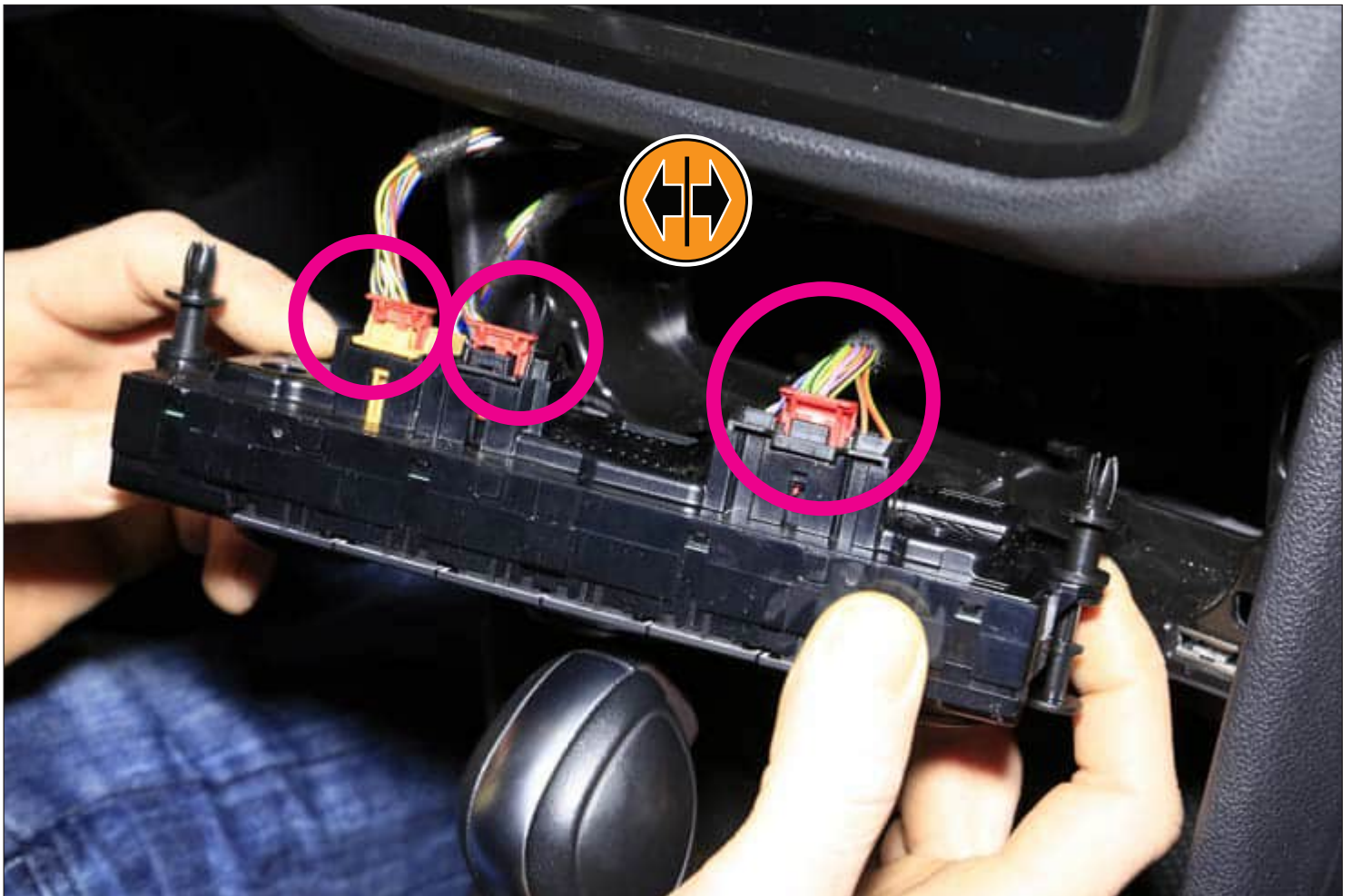

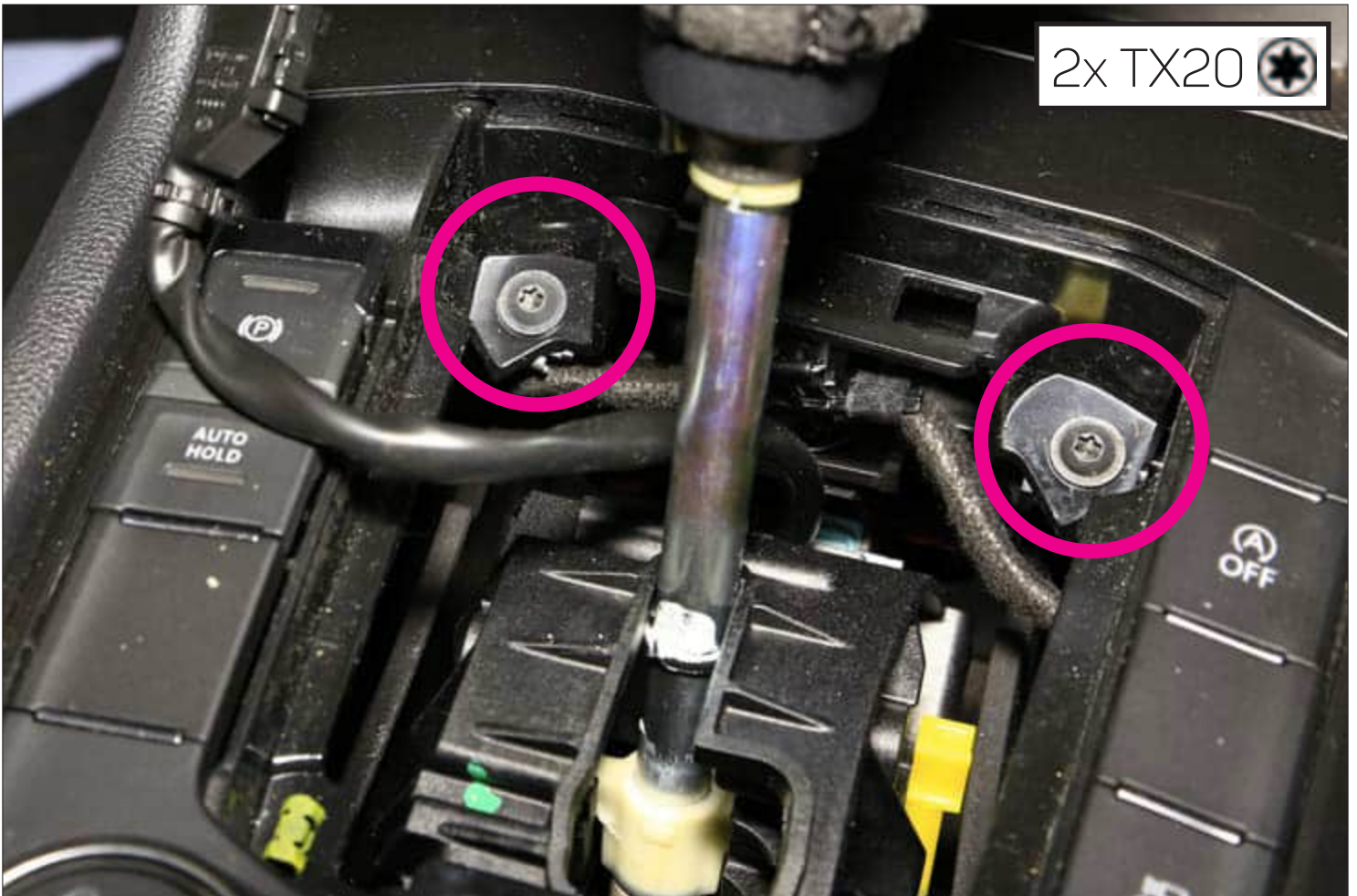
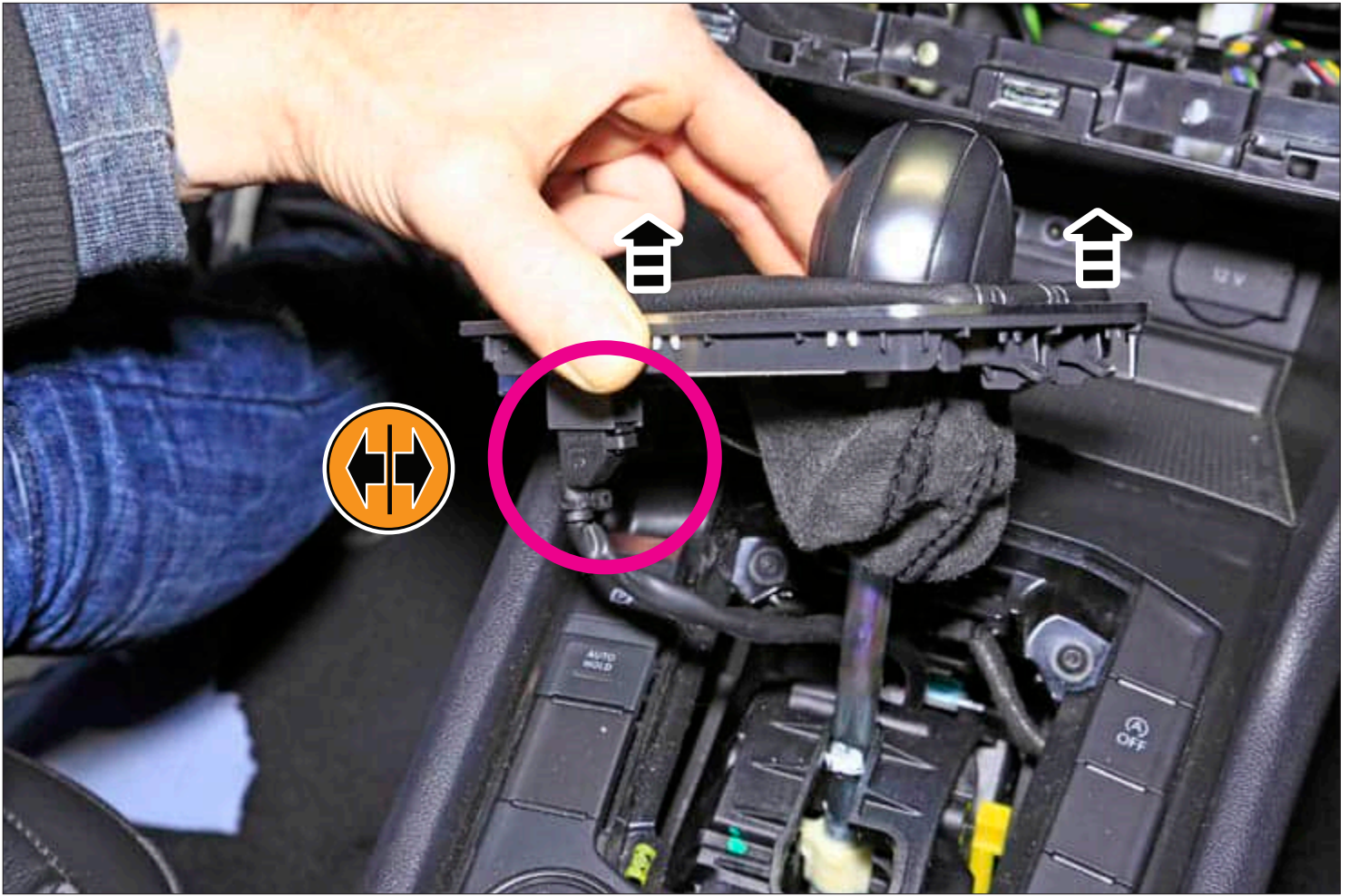

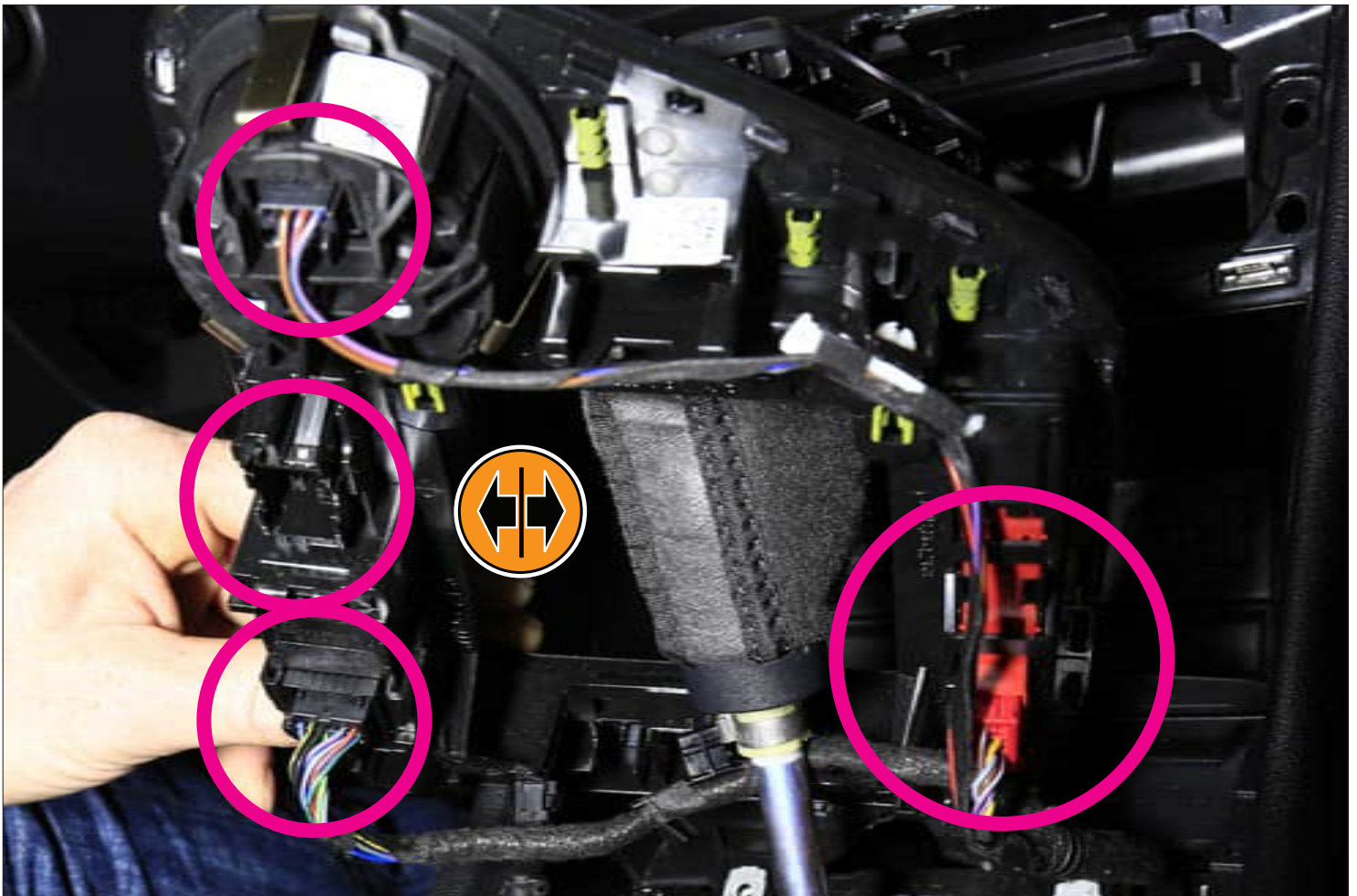

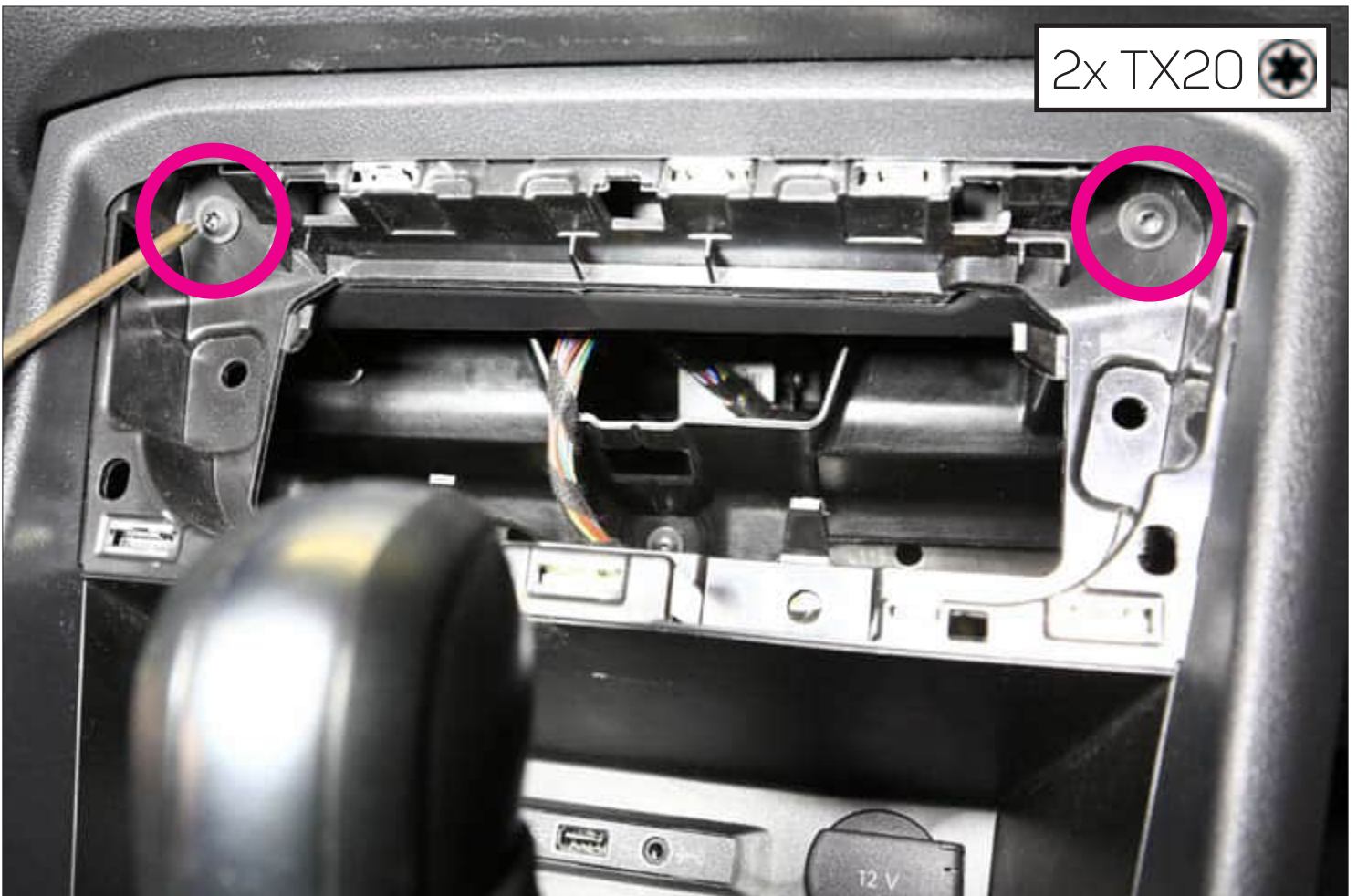



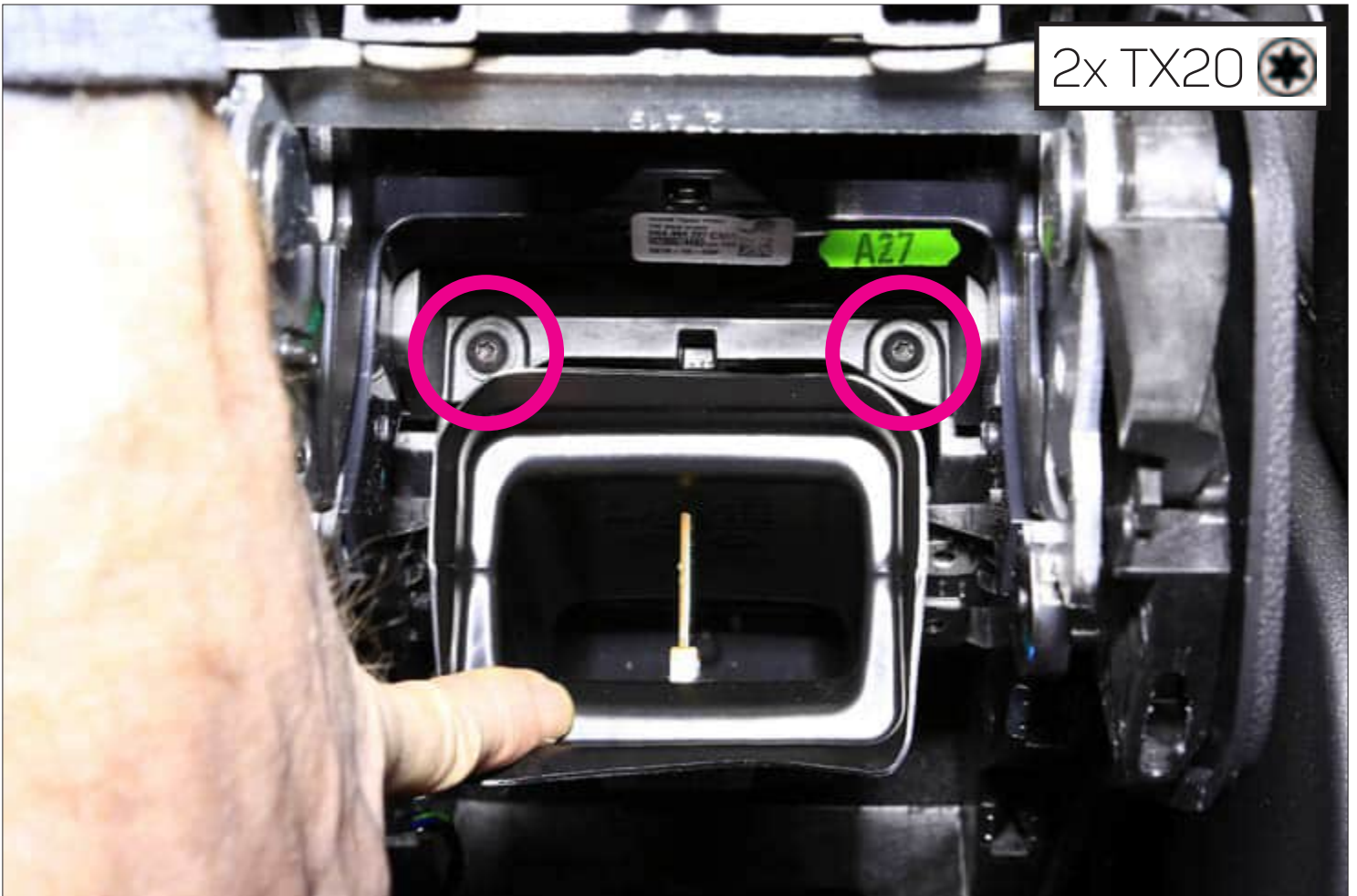
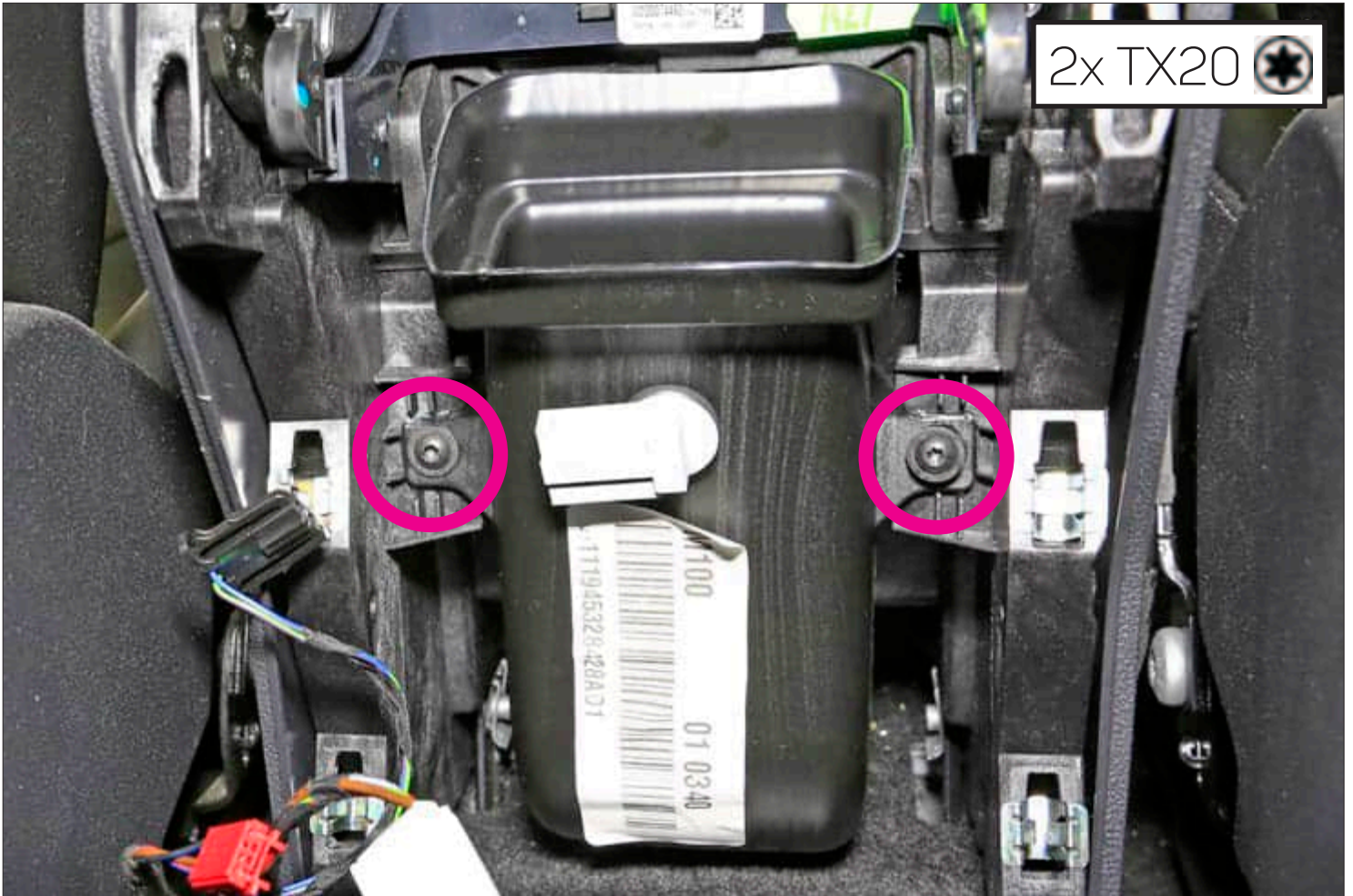



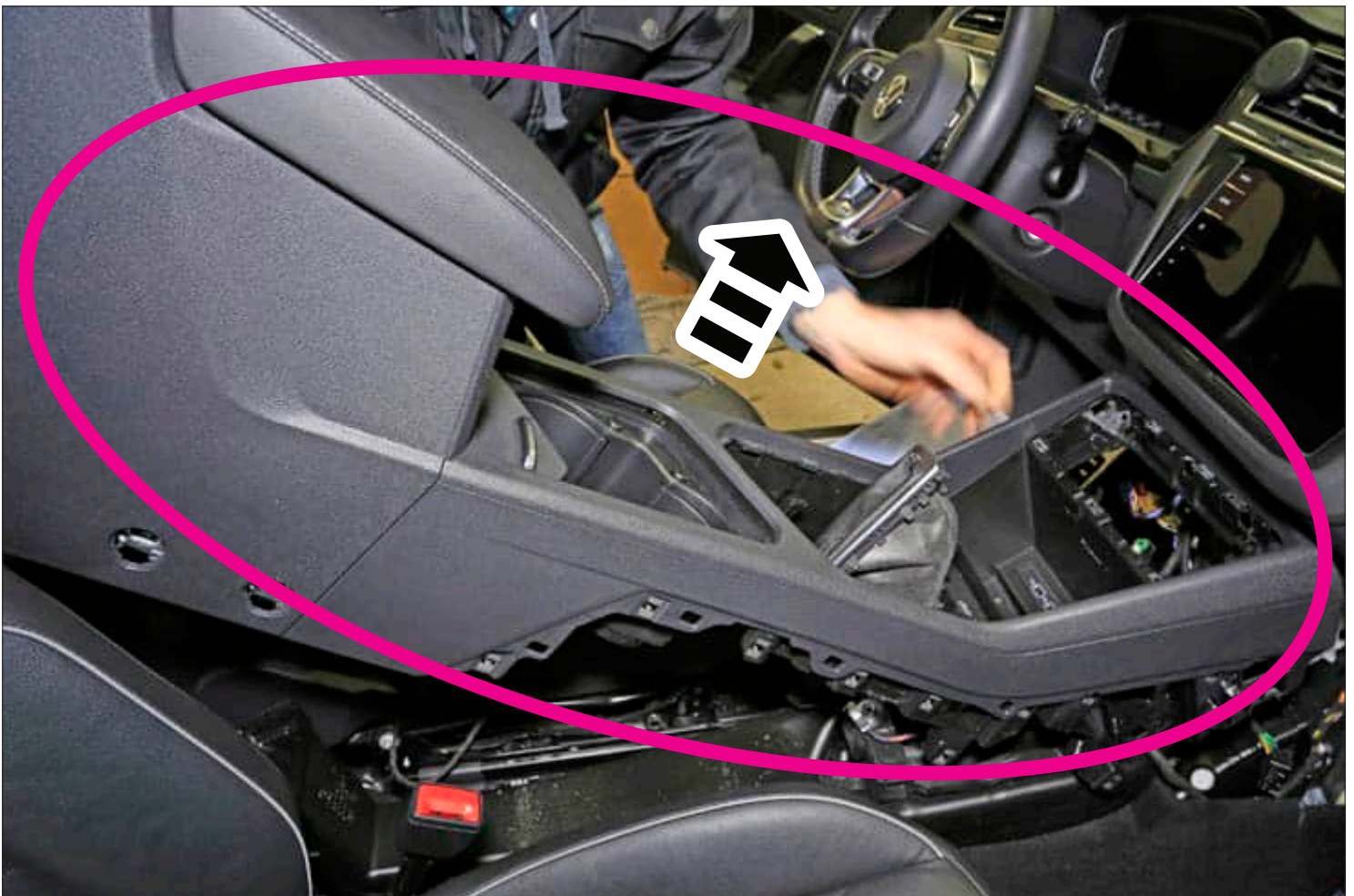
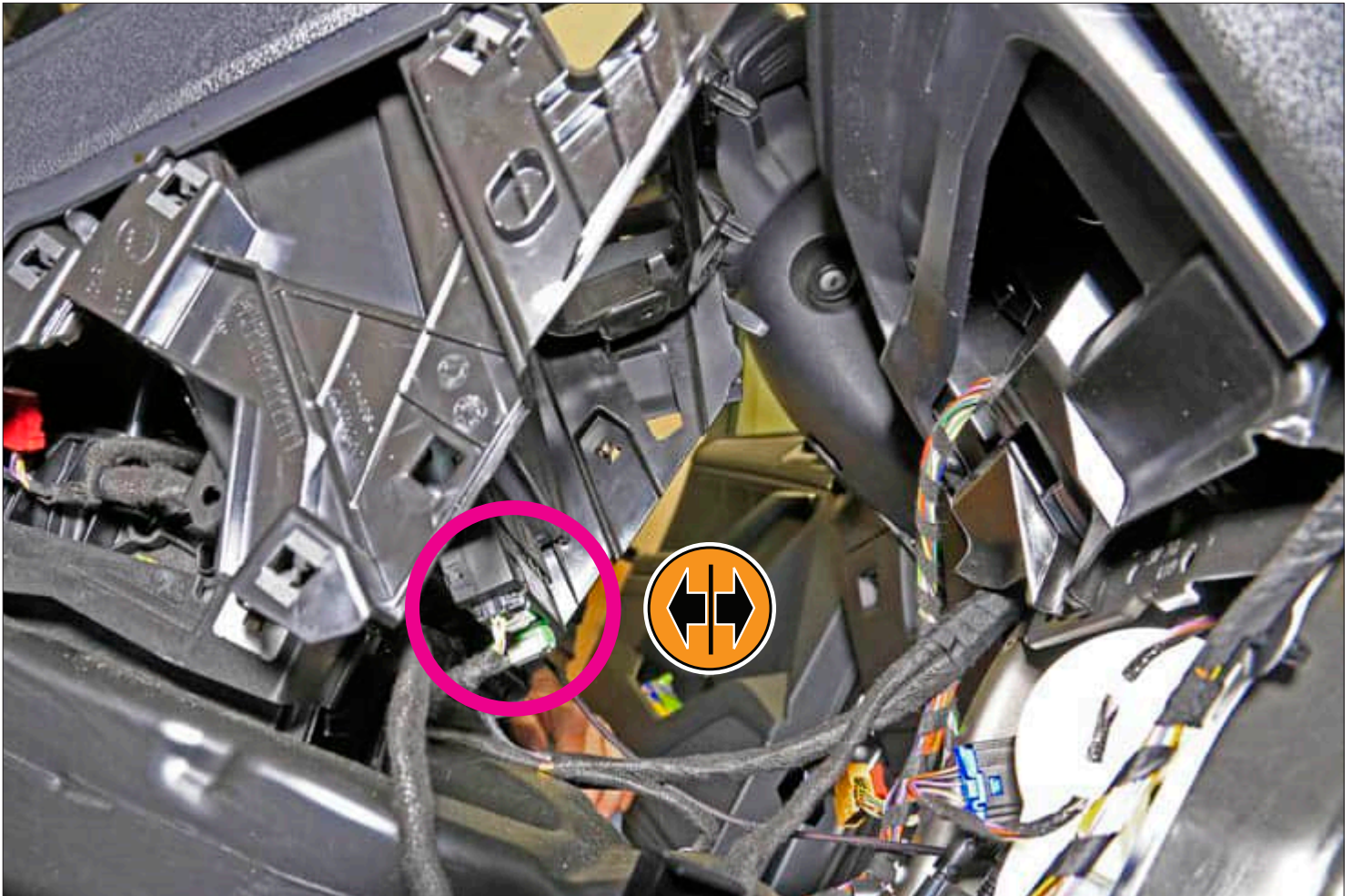



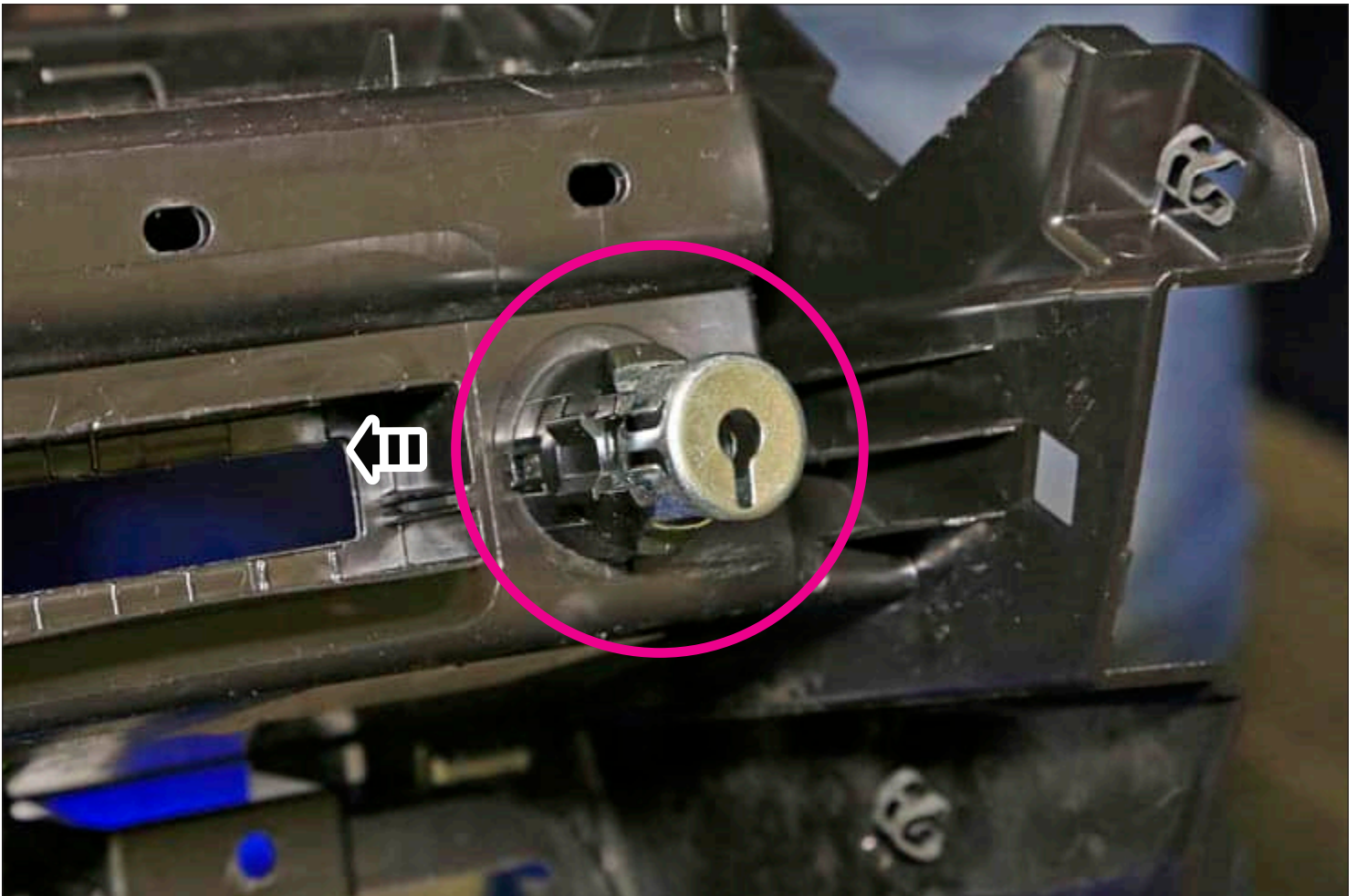





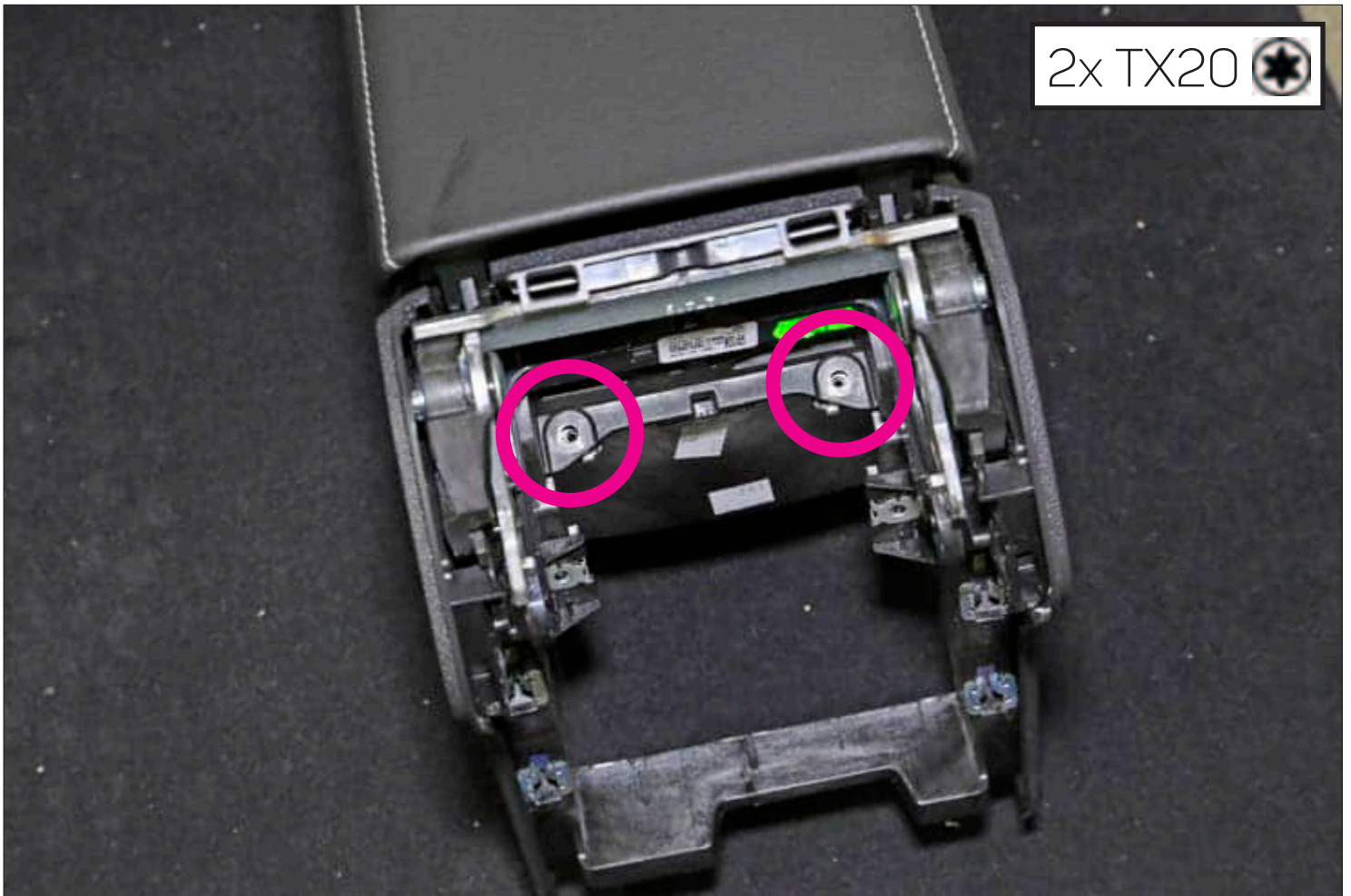

Modelle mit Blinddeckel
Models with blind cover

1x TX20 



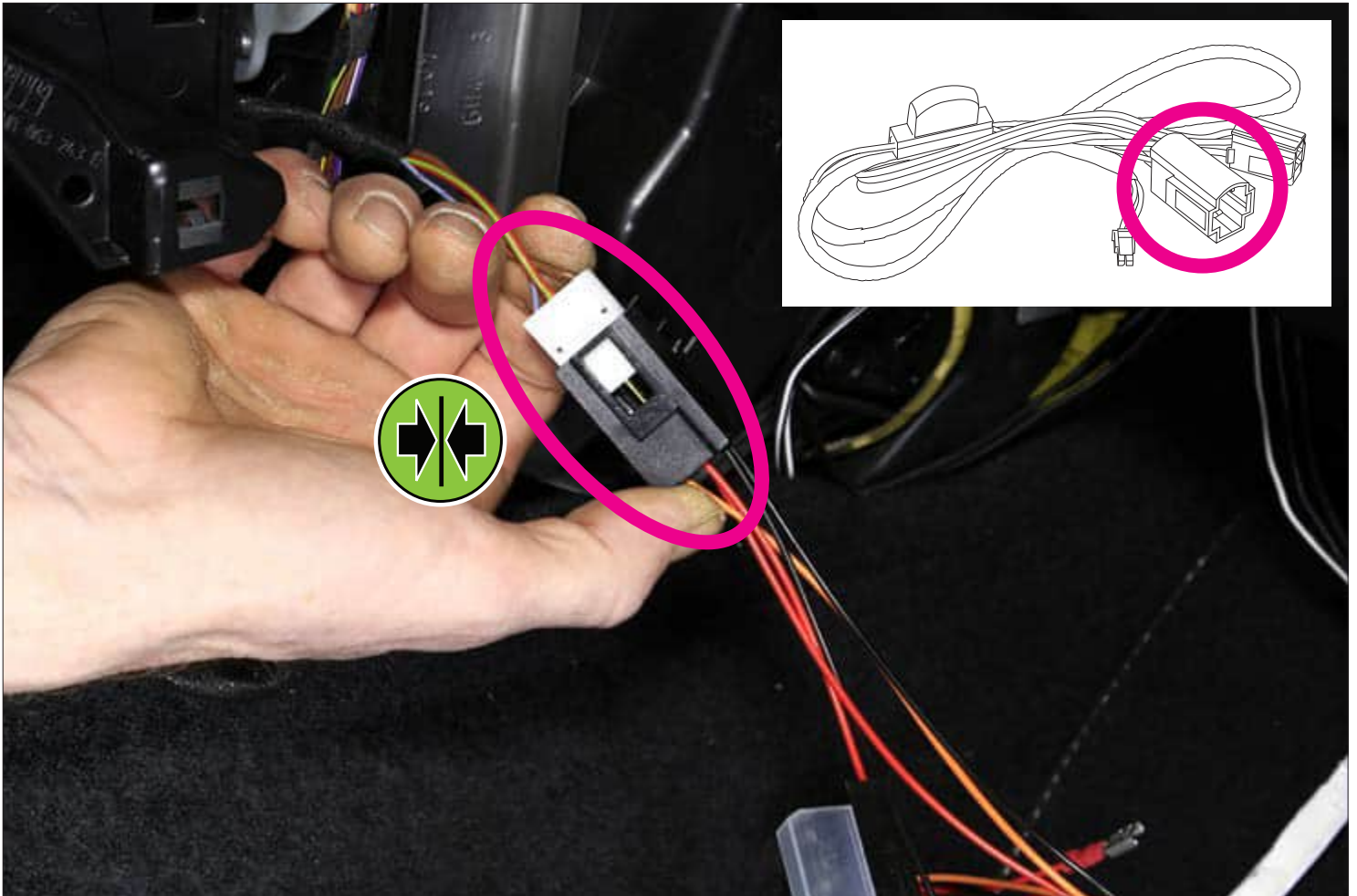
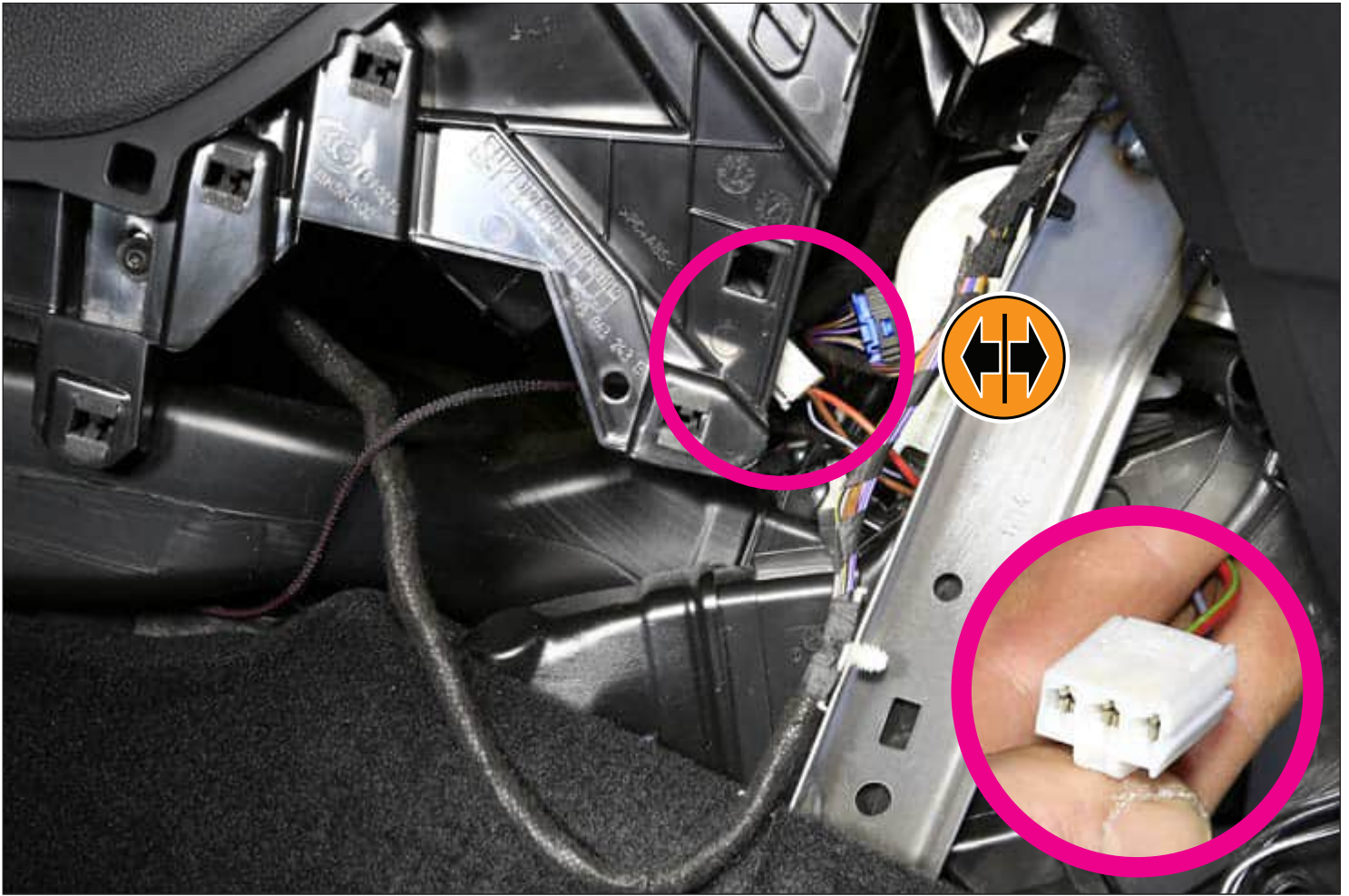

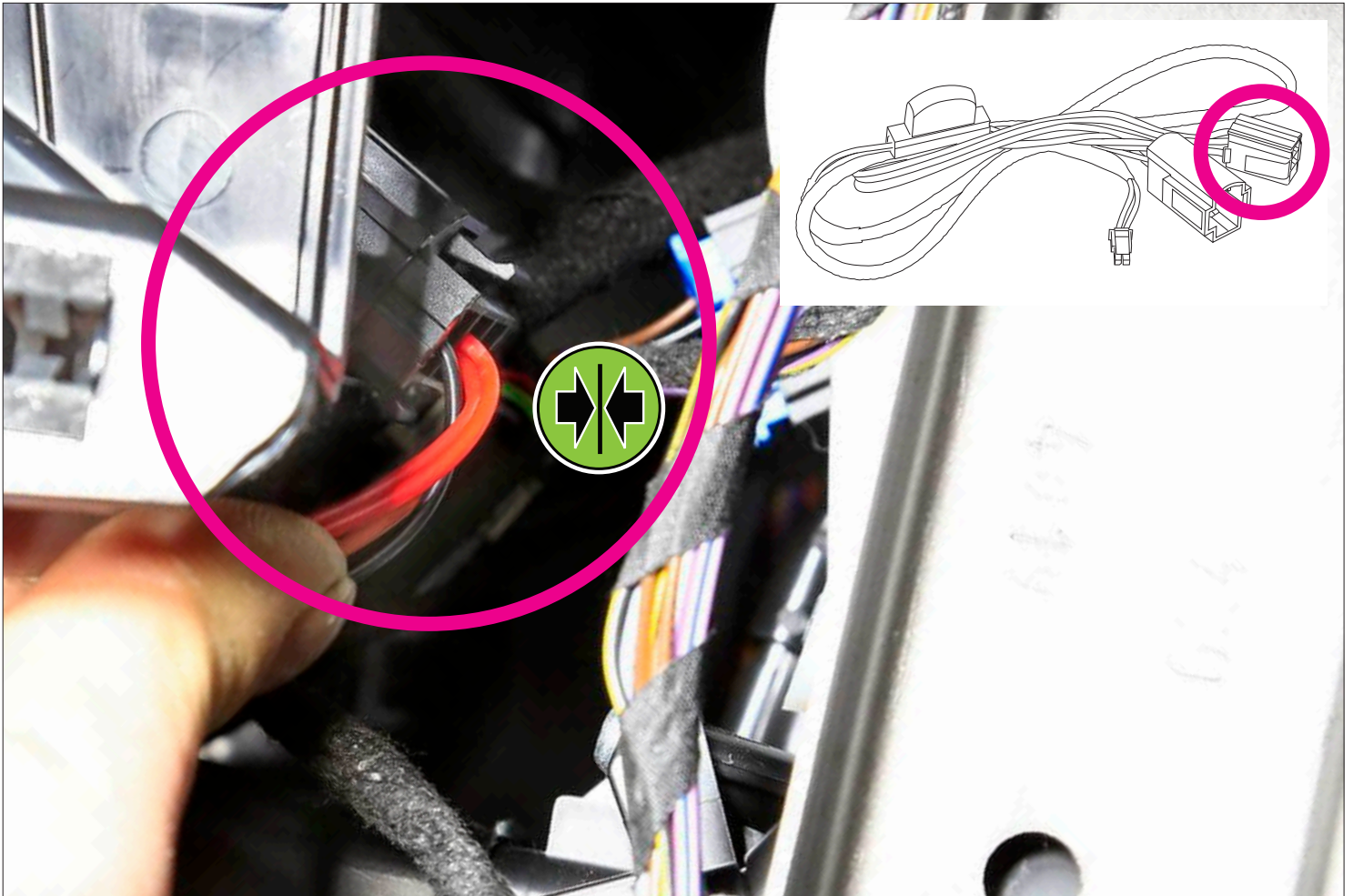

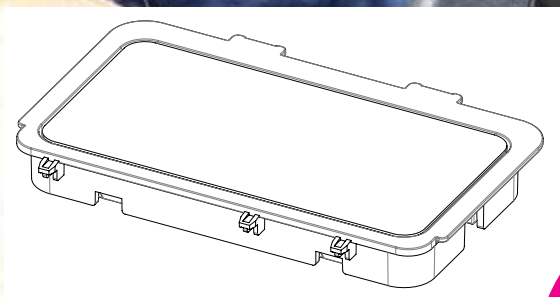
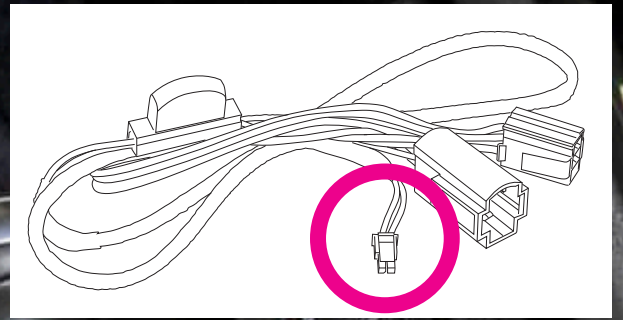
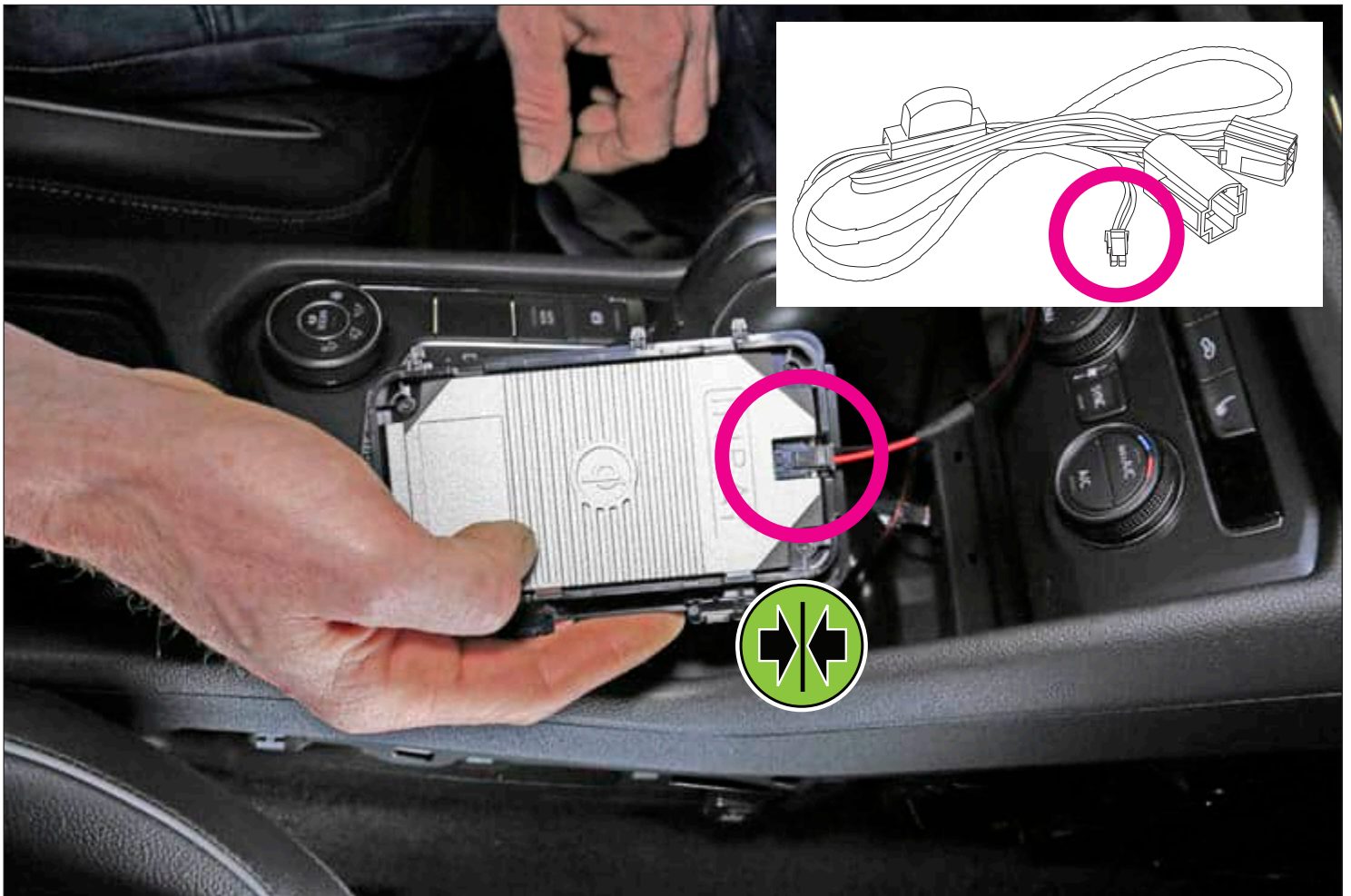

Tiguan: 5NB 863 330 A
Tiguan Allspace: 5NN 863 330 A



