



### Ford Transit (excludes factory radio delete models) 2020

Visit [MetraOnline.com](http://MetraOnline.com) for more detailed information about the product and up-to-date vehicle specific applications

#### KIT FEATURES

- ISO DDIN radio provision\*
- Painted scratch resistant matte black



\* This kit is designed for an ISO DDIN radio which have an "L" shaped chassis design, with the radio chassis at the bottom of the screen, or Pioneer modular 6.8" radios.

† Refer to the radio manufacturer for current models

#### KIT COMPONENTS

- A) Radio trim panel • B) Radio housing • C) Sub dash brackets • D) Radio brackets • E) Panel clips (3) • F) #8 x 1/2" Phillips screws (4)

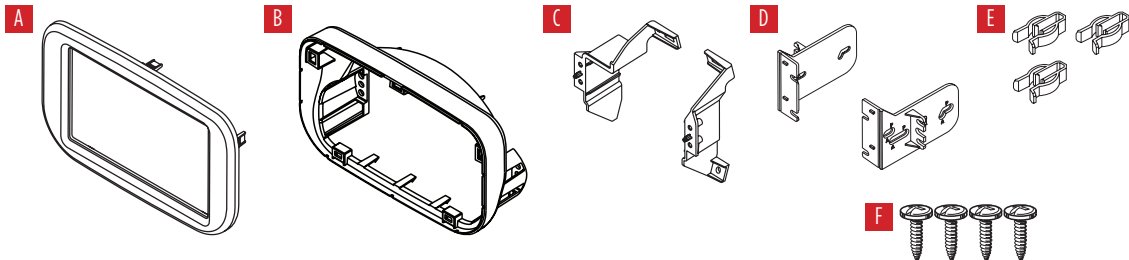

#### TABLE OF CONTENTS

Dash Disassembly .....	2
Kit Preparation .....	3
Kit Assembly	
–ISO DDIN radio provision .....	4
–Pioneer Modular radio provision .....	5

#### WIRING & ANTENNA CONNECTIONS (sold separately)

See [metra-online.com](http://metra-online.com) or [axessinterfases.com](http://axessinterfases.com) for audio and SWC interface options  
Antenna Adapter: 40-EU10

#### TOOLS REQUIRED

- Panel removal tool • 9/32" socket
- Phillips screwdriver • Cutting tool

**Attention!** Let the vehicle sit with the key out of the ignition for a few minutes before removing the factory radio. When testing the aftermarket equipment, ensure that all factory equipment is connected before cycling the key to ignition.

## DASH DISASSEMBLY

1. Unclip the trim behind the radio display, then remove (3) 9/32" screws exposed. (Figure A)
2. Slide the radio display up and out, then unplug and remove. (Figure B)
3. Remove (2) screws securing the center dash panel, then unclip, unplug, and remove. (Figure C)

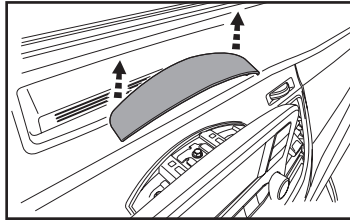

(Figure A)

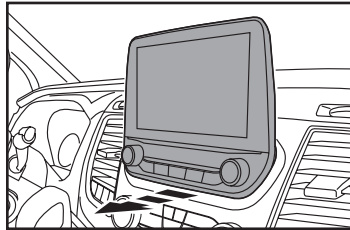

(Figure B)

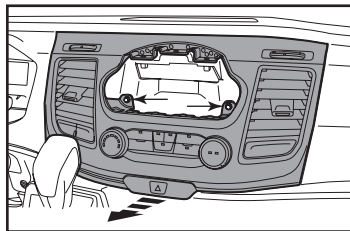

(Figure C)

4. Remove (4) 9/32" screws securing the radio display mount, then remove. (Figure D)
5. Unplug the connectors from the radio chassis. Remove (2) 9/32" screws securing the chassis, slide out, then remove. (Figure E)

*Continue to Kit Preparation*

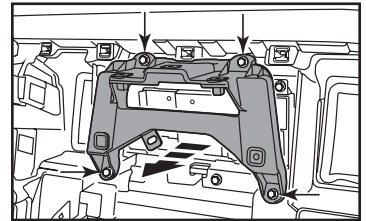

(Figure D)

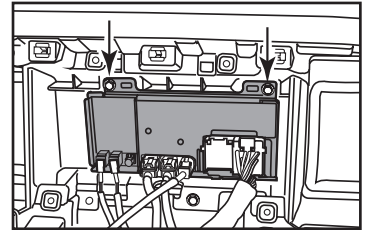

(Figure E)

## KIT PREPARATION

1. Attach the (3) included **panel clips** to the **radio trim panel**. (Figure A)
2. Cut and remove the two lower mounting tabs from the inside of the factory dash panel radio opening. (Figure B)

*Continue to Kit Assembly*

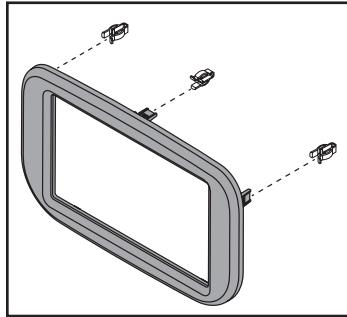

(Figure A)

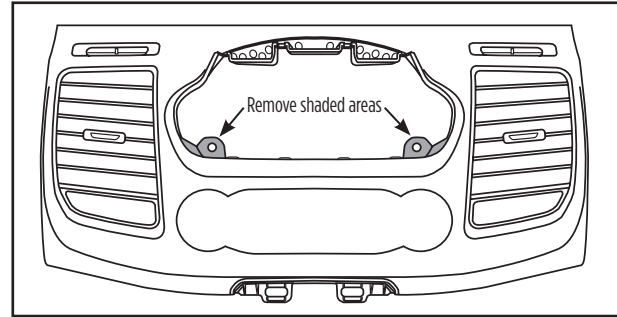

(Figure B)

## KIT ASSEMBLY

### Bottom chassis radio provision

1. Secure the **sub-dash brackets** to the dash using the factory screws. (Figure A)
2. Snap off the front of the **radio brackets** and secure them to the radio using screws supplied with the radio. (Figure B, C)
3. Snap the **radio housing** into the factory dash panel. (Figure D)
4. Snap the factory dash panel back in place.

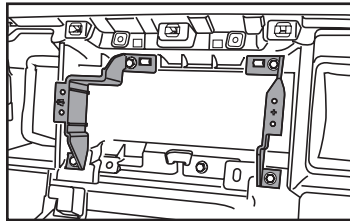

(Figure A)

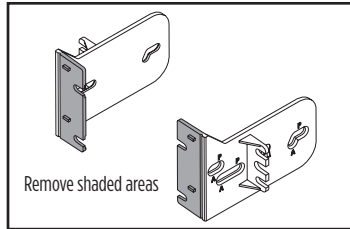

(Figure B)

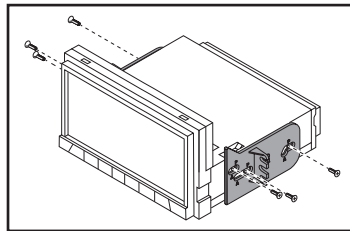

(Figure C)

5. Locate the factory wiring harness and antenna connector in the dash and complete all necessary connections to the radio. Metra recommends using the proper mating adapter from Metra and/or Axxess. Test the radio for proper operation.
6. Slide the radio assembly into the dash and secure to the **radio housing** using the (4) included Phillips screws. (Figure E)
7. Snap the **radio trim panel** into the radio housing. (Figure F)

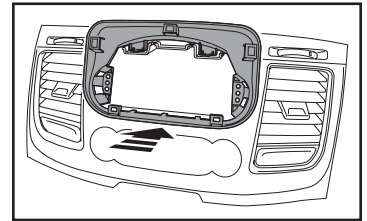

(Figure D)

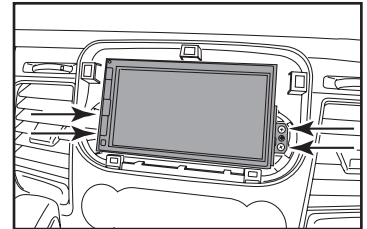

(Figure E)

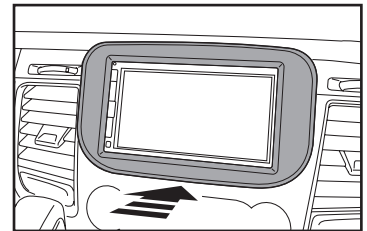

(Figure F)

## KIT ASSEMBLY

### Pioneer Modular DDIN radio provision

**Note:** For steps 2 and 3, reference the installation manual provided with the radio for which hardware to use. The display screen and radio chassis use two different types of screws.

1. Secure the **sub-dash brackets** to the dash using the factory screws. (Figure A)
2. Secure the **radio brackets** to the radio display using (4) screws supplied with the radio. (Figure B)
3. Secure the **radio brackets** to the radio chassis using (4) screws supplied with the radio. (Figure C)
4. Snap the **radio housing** into the factory dash panel. (Figure D)
5. Snap the factory dash panel back in place.

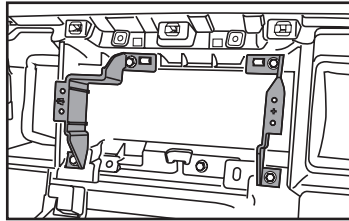

(Figure A)

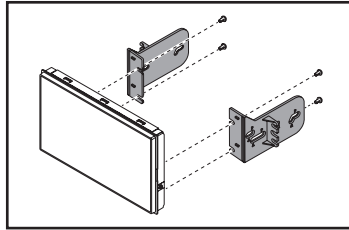

(Figure B)

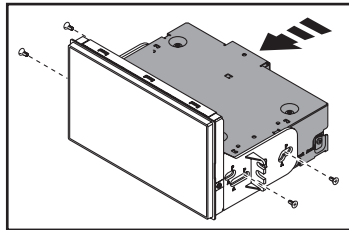

(Figure C)

6. Locate the factory wiring harness and antenna connector in the dash and complete all necessary connections to the radio. Metra recommends using the proper mating adapter from Metra and/or Axxess. Test the radio for proper operation.
7. Slide the radio assembly into the dash and secure to the **radio housing** using the (4) included Phillips screws. (Figure E)
8. Snap the **radio trim panel** into the radio housing. (Figure F)

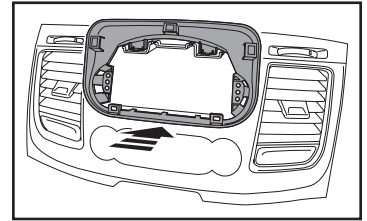

(Figure D)

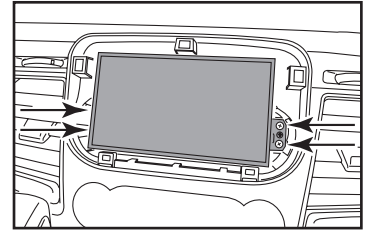

(Figure E)

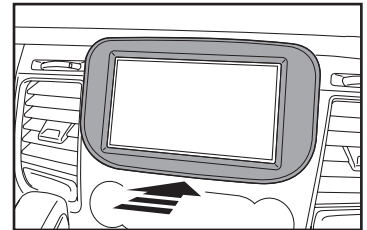

(Figure F)





---

---

---

---

---

---

---

---

---

---

---

---

---

---

---

---

---

---

---

---

---

---

---

---

---

---

---

---

---

---

---

---

---

---

---

---

---

---

---

---

---

---

---

---



# 107-FD1B

INSTALLATION INSTRUCTIONS



Having difficulties? We're here to help.



Contact our Tech Support line at:

**386-257-1187**



Or via email at:

[techsupport@metra-autosound.com](mailto:techsupport@metra-autosound.com)

### Tech Support Hours (Eastern Standard Time)

Monday - Friday: 9:00 AM - 7:00 PM

Saturday: 10:00 AM - 7:00 PM

Sunday: 10:00 AM - 4:00 PM



### **KNOWLEDGE IS POWER**

Enhance your installation and fabrication skills by enrolling in the most recognized and respected mobile electronics school in our industry. Log onto [www.installerinstitute.com](http://www.installerinstitute.com) or call 800-354-6782 for more information and take steps toward a better tomorrow.



**Metra recommends MECP certified technicians**